

Caravanes piantes

*Trailer tents
Camping cars
Zeltanhänger
Remolques de campaña
Carrelli tenda tela*



2

0

0

7

2007

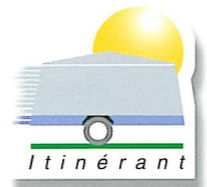

Solena p8



Minto p3



Florès p4



Jasmin p6



Allegra p10



Quick Stop p12



Globe Trotter p14

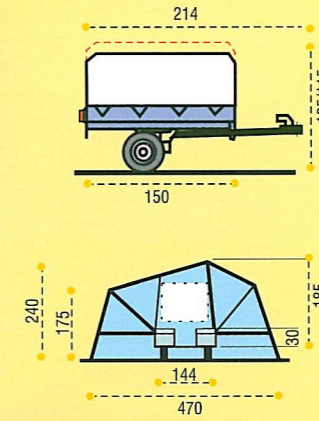
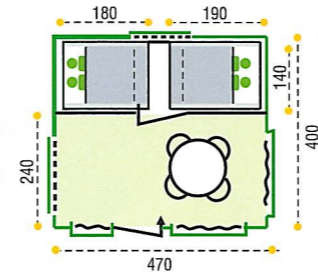

Minto®

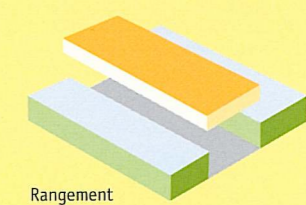

Rangement
Storage
Opberg ruimte
Verstauen
Assettamento
Aparcamiento

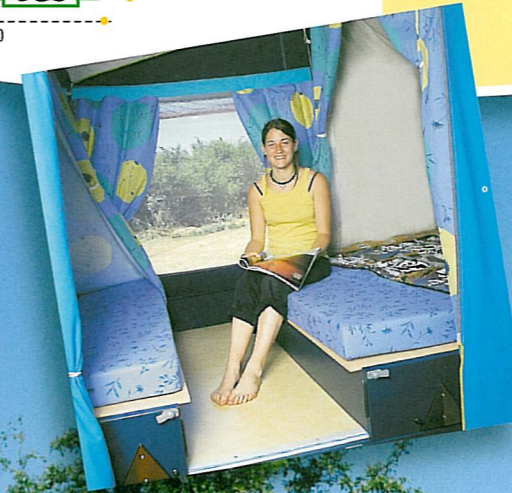

Florès



Rangement
Storage
Opbergruimte
Verstauen
Assettamento
Aparcamiento

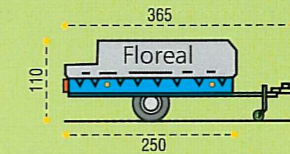
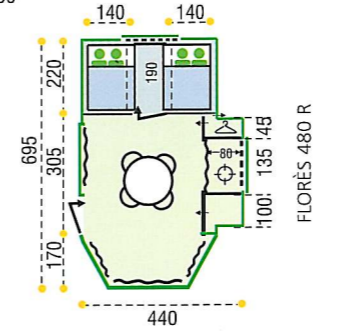
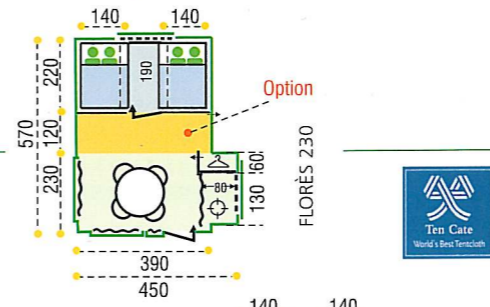
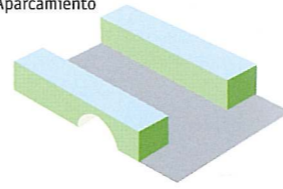

Floreal

Florès

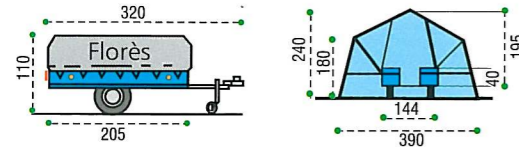

Florès 480 R



Florès 230



Florès 230



Florès 480 R



Jasmin

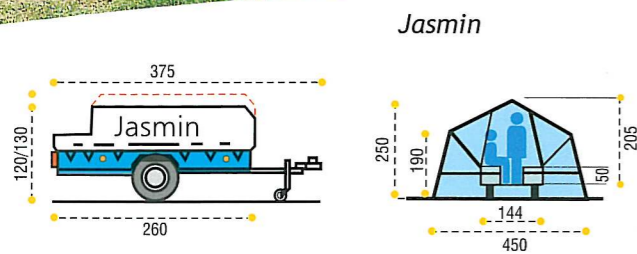

Jasmin

Rangement
Storage
Opberg ruimte
Verstauen
Assettamento
Aparcamiento

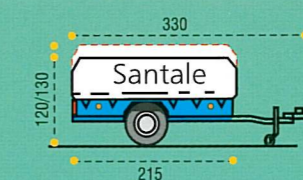
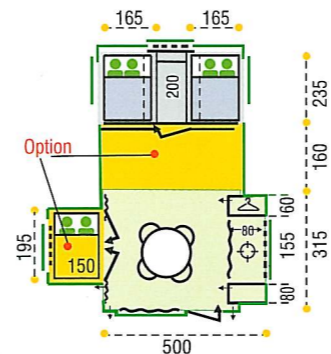
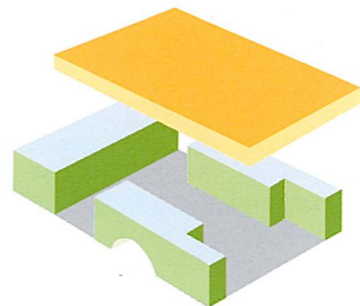

Santale

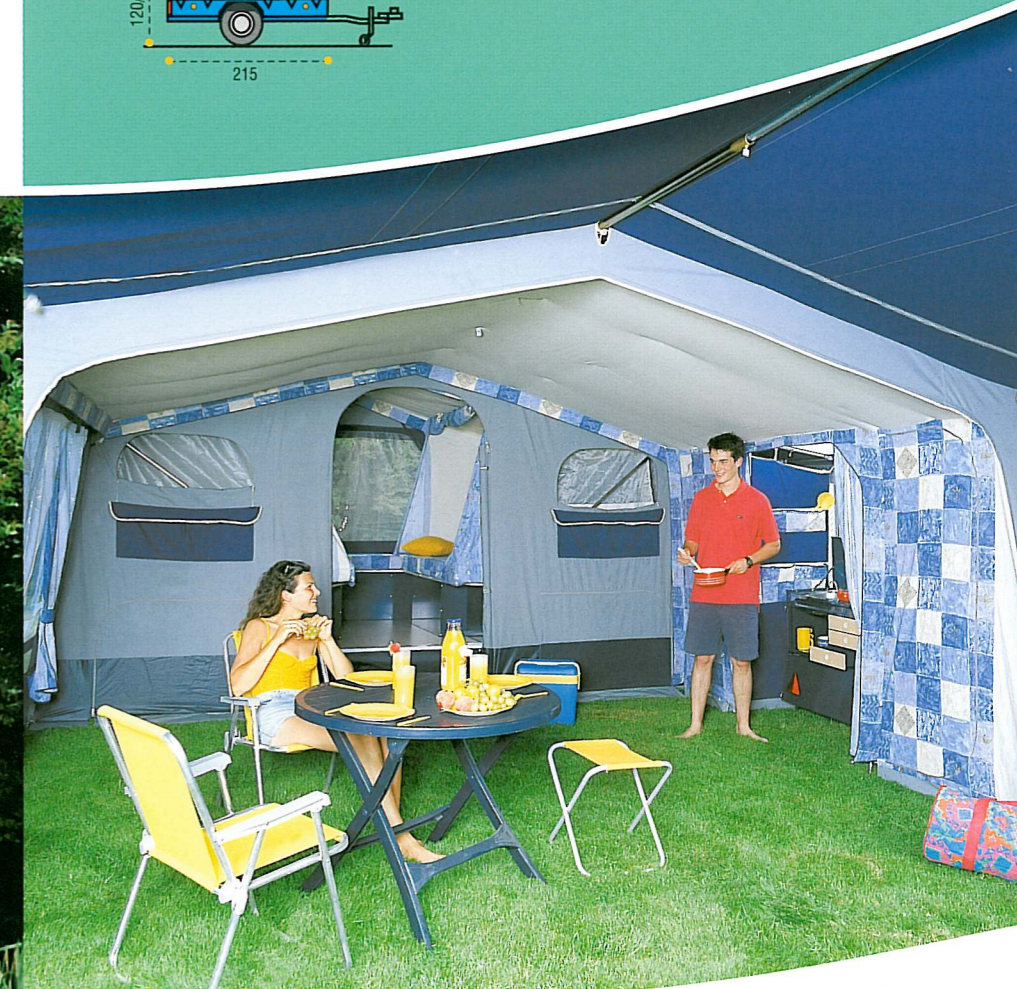

Sommiers à lattes isolés
Insulated slatted beds
Isolierte Lattenrostbetten

Lattenbodem
Letto a doghe
Somier de láminas

Solena[®]

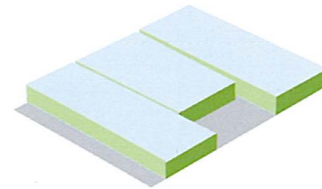
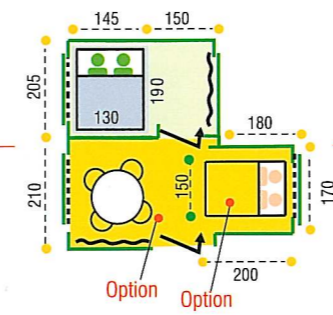
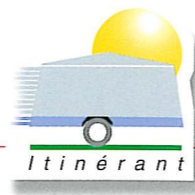

Rangement
Storage
Opbergruimte
Verstauen
Assettamento
Aparcamiento



Montage ultra rapide sans piquets.
Very quick erecting without pegs.
Ongeloofelijk snel op te zetten
Zonder tentharingen.
Sehr schneller Aufbau ohne Heringe.
Montaggio ultra rapido senza picchetti.
Montaje ultra-rápido sin piquetas.

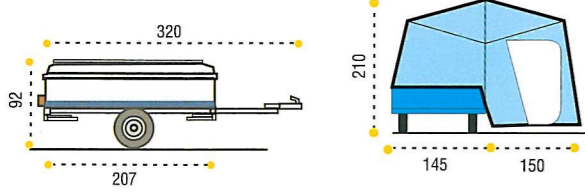

Allegra

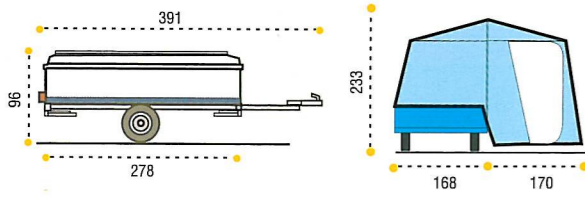
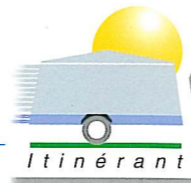

Rangement
Storage
Opberg ruimte
Verstauen
Assettamento
Aparcamiento

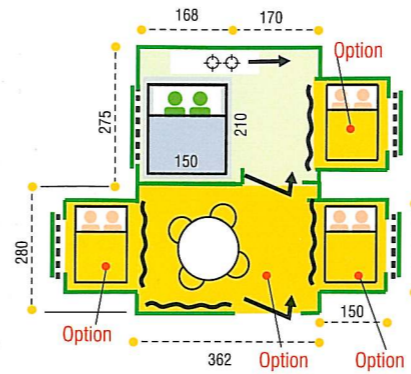
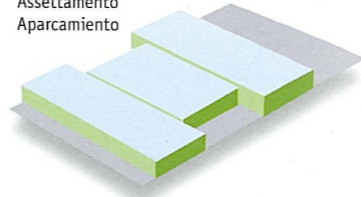

Montage ultra rapide sans piquets.
Very quick erecting without pegs.
Ongeloofelijk snel op te zetten
Zonder tentharingen
Sehr schneller Aufbau ohne Heringe.
Montaggio ultra rapido senza picchetti.
Montaje ultra-rápido sin piquetas.





Quick Stop

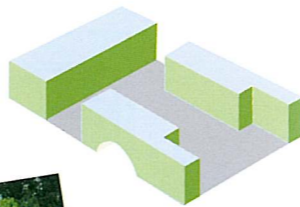
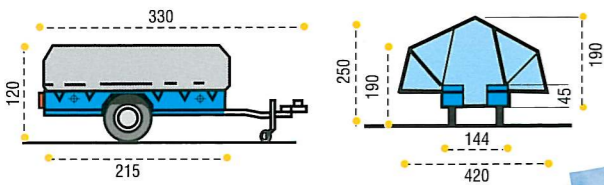

Rangement
Storage
Opbergruimte
Verstauen
Assettamento
Aparcamiento

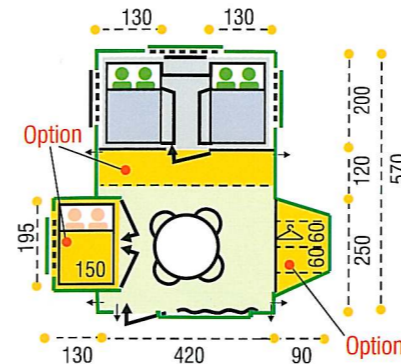

Montage ultra rapide sans piquets.
Very quick erecting without pegs.
Ongeloofelijk snel op te zetten
Zonder tentharingen
Sehr schneller Aufbau ohne Heringe.
Montaggio ultra rapido senza picchetti.
Montaje ultra-rápido sin piquetas.



Globe Trotter®

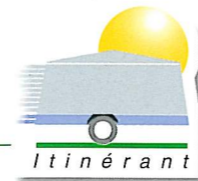

Réfrigérateur
Refrigerator
Kühlschrank
Koelkast
Frigorifero
Frigorifico



56 L

Pompe à eau
Water pump
Waterpomp
Wasserpumpe
Pompa dell'acqua
Bomba de agua



220 V

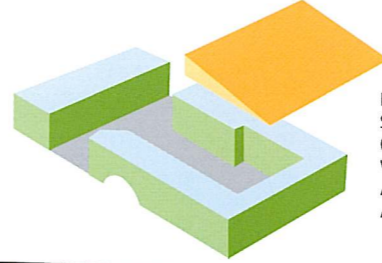

Rangement
Storage
Opbergruimte
Verstauen
Assettamento
Aparcamiento

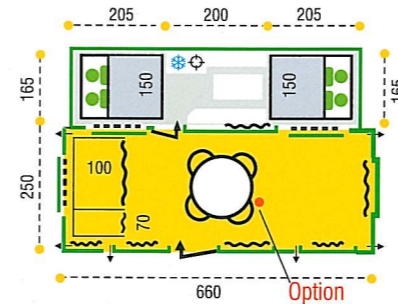
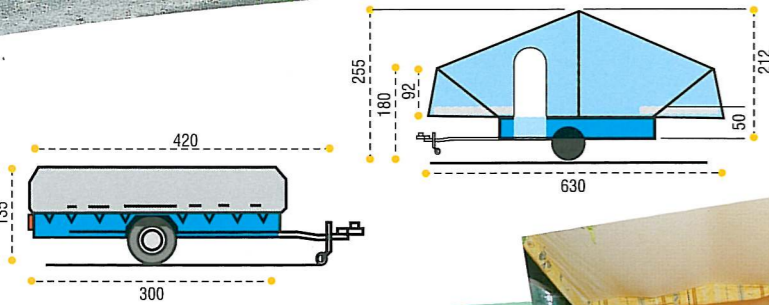

Montage ultra rapide sans piquets.
Very quick erecting without pegs.
Ongeloofelijk snel op te zetten
Zonder tentharingen
Sehr schneller Aufbau ohne Heringe.
Montaggio ultra rapido senza picchetti.
Montaje ultra-rápido sin piquetas.

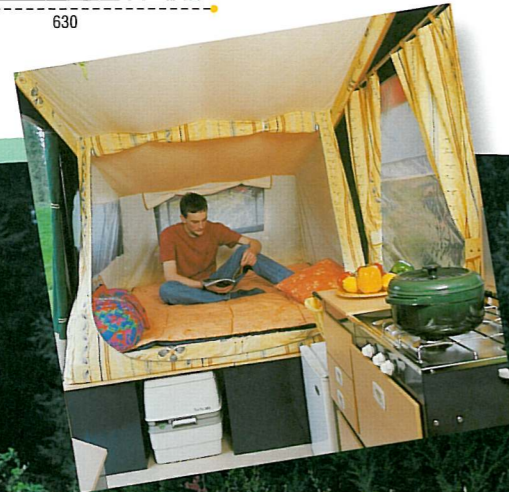

Technique

Technique
Techniek
Technik
Tecnica
Técnica

Les équipements ainsi que les caractéristiques peuvent varier en fonction des pays.
The fittings as well technical data can vary according to each country.
Die Ausstattungen sowie die technischen Angaben können je nach Land variieren.
De uitvoeringen evenals de technische opgaven kunnen per land verschillen.
Los equipos y las características técnicas pueden cambiar de un país a otro.
Le dotazioni e le caratteristiche tecniche potranno variare.

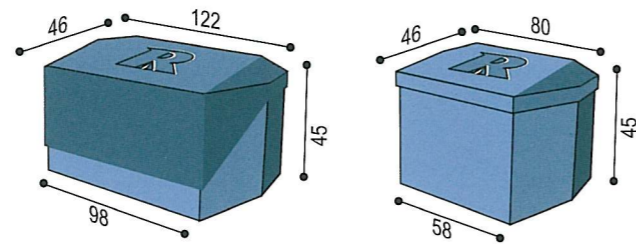

	MINTO	FLORES			JASMIN		SOLENA	ALLEGRA	QUICK STOP	GLOBE TROTTER
		FLORES 230	FLORES 480 R	FLOREAL	JASMIN	SANTALE				
Poids à vide / Weight (excl. bagage) Leeggewicht / Eigen gewicht P.A.V / Peso proprio	200 kg	310 kg 350 kg	310 kg 350 kg	335 kg 375 kg	375 kg	350 kg	270 kg	450 kg	380 kg	520 kg
Poids total en charge / Maximum loaded weight Max.toelaatbaar gewicht / Max. Gesamtgewicht P.A.PC / Peso total	450 kg	495 kg 650 kg (NL)	495 kg 650 kg (NL)	495 kg 650 kg (NL)	495 kg 650 kg (NL)	495 kg	400 kg	495 kg 650 kg (NL)	495 kg 650 kg (NL)	650 kg
Dimensions des roues / Size of wheels /Wielmaten / Radgrösse Dimensioni ruote / Dimensiones ruedas	16,5 x 6,5-8	500 x 10	500 x 10	500 x 10	135 x 13	135 x 13	16,5 x 6,5-8	135 x 13	135 x 13	135 x 13
Volume total / Total volume Totaal volume / Gesamt inhoude Volume totale / Volumen total	432 L	864 L	864 L	864 L	1238 L	1238 L	940 L	1755 L	1238 L	2227 L
Volume de rangement / Storage volume Laadruimte / Verstauen volumen Assetamento volume / Aparcamiento volumen	267 L	290 L	290 L	290 L	515 L	515 L	336 L	725 L	515 L	1148 L
Volume sous bache / Under cover volume Afdekzeil Laadruimte omder / Unter der plane volumen Sotto copertone volume / Bajo toldo volumen	82 L	-	-	-	464 L	464 L	-	-	-	239 L
Essieu freiné / Axle with brake Automatische oplooprem Achse mit Bremsvorrichtung und Rückfahrautomatik Assie con freno / Eje con freno	●	●	●	●	▲	▲	●	▲	▲	▲
 ARMACLIC	-	●	-	●	●	●	-	-	-	-

▲ D'origine / Standard / Standaard / Standard / De origen / Di Serie
● Option / Optional / Nach Wahl / Optie / Opcional / Opzione

Dépliage

Easy action erecting system
Eenvoudig opzetsysteem
Automatischer Aufbau
Apertura automática
Apertura automática



Armature télescopique entièrement solidarisée : ARMAclíc est deux fois plus légère qu'une armature acier traditionnelle. Elle se déploie et se replie en un clin d'oeil. Le réglage est fiable et très simple grâce à un astucieux système de bagues. ARMAclíc est en aluminium anodisé inaltérable diamètre 28 mm. Système breveté.

Fully inter-connected in dural it unfolds and re-folds again into one piece. International patents.

Parapluframe. Gemakkelijk in en uit te vouwen aluminium voortent frame. Het parapluframe is zo eenvoudig, je hoeft niet meer te knoeien met stokken, want alles zit aan elkaar vast en is eenvoudig door één persoon op te zetten. Internationaal gepatenteerd.

Aluminium-gestänge in einem Stück Patentiertes system.

Armatura in alluminio interamente unita. Modello brevettato.

Armodura aluminio del avance, de uno sola pieza (opcional). Sistema patentado Solena, Allegra, Quick Stop.



Equipements

Accessoires

	MINTO	FLORES			JASMIN		SOLENA	ALLEGRA	QUICK STOP	GLOBE TROTTER
		FLORES 230	FLORES 480 R	FLOREAL	JASMIN	SANTALE				
Coffre sur flèche / Towbar storage box Disselbak / Deichselkasten Cofre exterior / Arcon	1	-	•	•	•	•	•	•	•	▲
Pare-soleil / Sun awning Luifel / Sonnensegel Parasole / Visera-parasol	2	-	•	•	•	•	•	•	•	•
Galerie / Roof-rack Bagagedrager / Gepäckträger Portebagagli / Baca	3	•	•	•	•	•	▲	▲	•	-
Barres porte-tout (2) Rack adaptators bars (2) Zusatzprofile (2) / Bagagerek(2) Barres portatutto(2) / Barras de techo(2)	4	-	-	-	-	-	•	•	-	-
Chambre 2 places adaptable sous plateau Under-bed inner tent Tweepersoons-ondertent Zusatzschlaf-oder Staukabinen Camera 2 posti adattabili sotto ripiano Cuarto de 2 puetos adaptables bajo repisa	5	•	•	•	•	•	-	-	•	-
Chambre annexe / Bedroom annexe Schlafkabine / Slaapcabine Habitacion / Camera supplementare	6	-	-	-	•	•	•	•	•	-
Sommiers à lattes isolés / Insulated slatted beds Isolierte Lattenrostbetten / Latten bodem Letto a doghe / Somier de laminas	7	-	-	-	▲	▲	-	▲	-	-
Table / Table / Tafel / Tisch / Tavola / Mesa	8	-	•	•	•	•	-	•	▲	▲
Meuble cuisine / Kitchen unit / Keukenblok Küchenblok / Blocco cucina / Bloque cocina	9	-	-	▲	▲	▲	-	▲	▲	▲
Berceaux de garage / Storage brackets Kantelbeugels / Kippvorrichtung / Archi di remessagio / Mensulas de estacionamiento	10	-	•	•	•	•	•	-	•	-
Coffres sous banquettes / Bench storage lockers OpBergruimte onder zitbankem Staukästen unter Sitzflächen Bauletti sotto panchine / Cofres bajo los asientos	11	▲	▲	▲	▲	▲	-	-	▲	▲
Roue jockey / Jockey wheel Telescopisch neuswiel / Bugrad Ruota Jockey / Rueda jockey	12	▲	▲	▲	▲	▲	▲	▲	▲	▲
Aération chambre double volet / Ventilated inner tents Goede ventilatie mogelijkheden Zimmerbelüftung-Doppelvorhänge Finestra camera sotto ripiano Ventilación habitaciones	13	-	▲	▲	▲	▲	▲	▲	▲	▲





Haut Eclair
72600 MAMERS - France
Tél 02 43 31 12 30
Fax 02 43 31 12 31
contact@raclet.fr

www.raclet.fr

Notre catalogue ne peut être considéré comme contractuel. Nous nous réservons la possibilité d'apporter toutes modifications que nous jugeons utiles à nos produits.

Our catalogue cannot be considered as contractually binding. We reserve the right to make any modification we consider necessary to our products.

Deze folder mag niet als contractueel worden beschouwd. Raclet behoudt zich het recht voor om technische en commerciële verbeteringen door te voeren.

Unser katalog ist vertraglich nicht bindend. Wir behalten uns das Recht vor, jederzeit für uns nützliche Änderungen vorzunehmen.

Il nostro catalogo non può essere ritenuto contrattuale, ci riserviamo la possibilità di apportare ogni modifica da noi ritenuta utile ai nostri prodotti.

Nuestro catalogo ne puede estar considerado como carácter contractual. Nos reservamos la posibilidad de anadir toda modificación que sea oportuna.