

# Caravanes pliantes

2005



**Trailer tents**  
**Vouwwagens**  
**Zeltanhänger**  
**Remolques de campaña**  
**Carrelli tenda tela**



# Minto®

**200 kg**

Poids à vide  
Weight (excl. baggage)  
Eigengewicht  
Eigen gewicht  
P.A.V.  
Peso propio

**450 kg**

Poids total en charge  
Maximum loaded weight  
Max. toelaatbaar gewicht  
Max. Gesamtgewicht  
P.A.P.C.  
Peso total

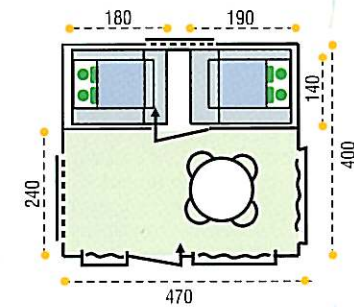
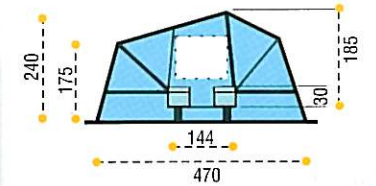
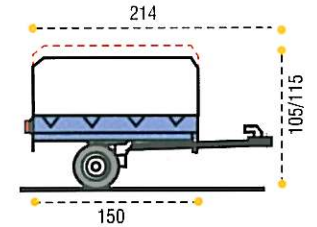

5002



432 L



267 L



82 L



\* 51

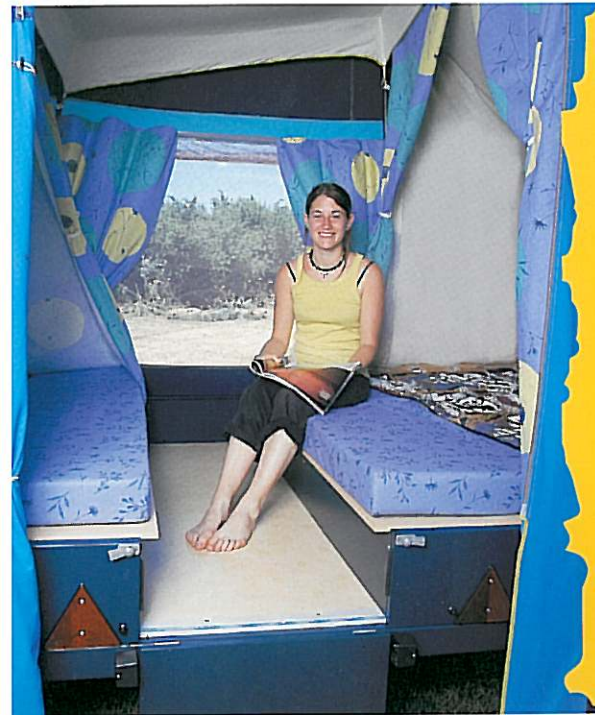



**RACLET**

*Caravanes Pliantes*



3

**Florès**  
**310 kg / 350 kg**  
**Floreal**  
**335 kg / 375 kg**

Poids à vide  
 Weight (excl. bagage)  
 Eigengewicht  
 Eigen gewicht  
 P.A.V.  
 Peso proprio

**Florès**  
**495 kg**  
**Floreal**  
**495 kg**  
**650 kg (NL)**

Poids total en charge  
 Maximum loaded weight  
 Max. toelaatbaar gewicht  
 Max. Gesamtgewicht  
 P.A.P.C.  
 Peso total

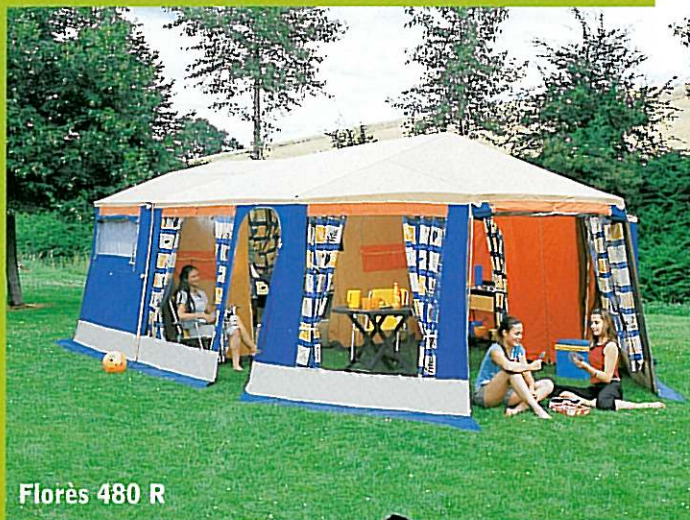
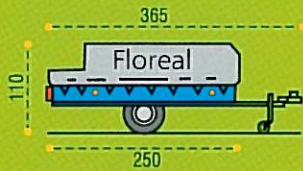
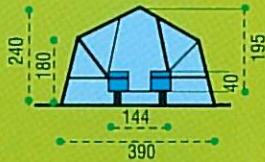

# Florès

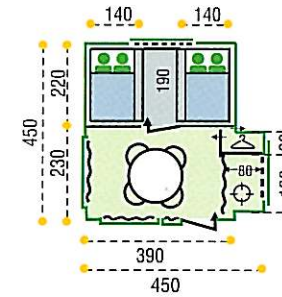

FLORÈS 230

59

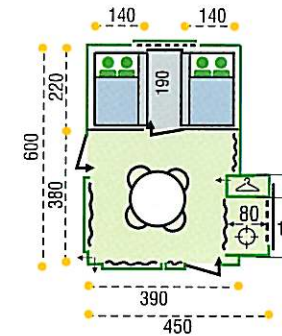

FLORÈS 380

60

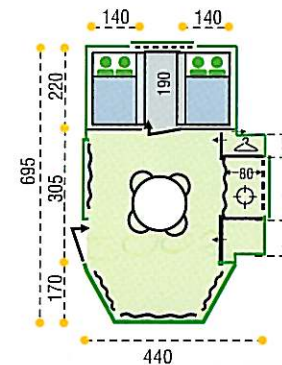

FLORÈS 480 R

61

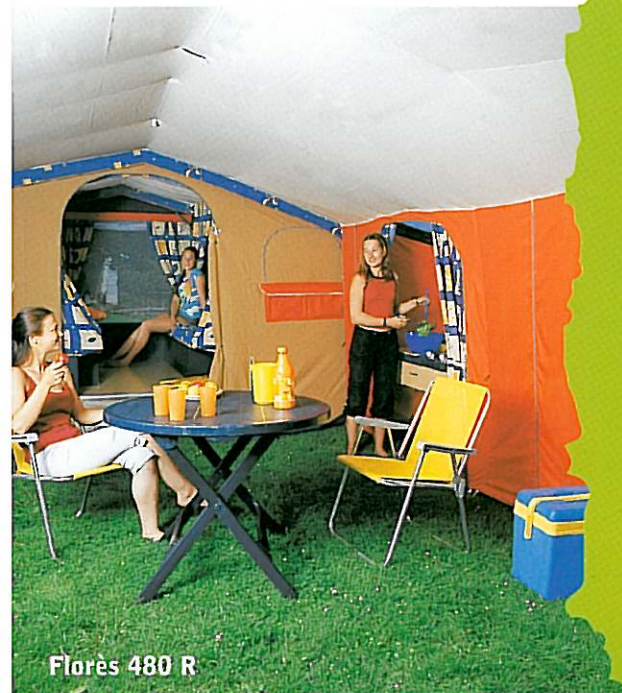

Florès 480 R



500 x 10



864 L



290 L

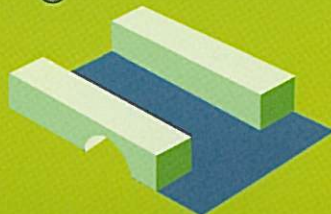



Flores 380



Flores

Option  
Optie  
Nach Wahl  
Optional  
Opcional  
Opzione



Flores 230



RACLET  
Caravanet Phantom



**Louxor**  
350 kg  
**Antalia**  
375 kg

Poids à vide  
Weight (excl. bagage)  
Eigengewicht  
Eigen gewicht  
P.A.V.  
Peso proprio

**Louxor**  
495 kg  
**Antalia**  
495 kg

650 kg (NL)  
Poids total en charge  
Maximum loaded weight  
Max. toelaatbaar gewicht  
Max. Gesamtgewicht  
P.A.P.C.  
Peso total



135x13



1238 L



515 L



464 L

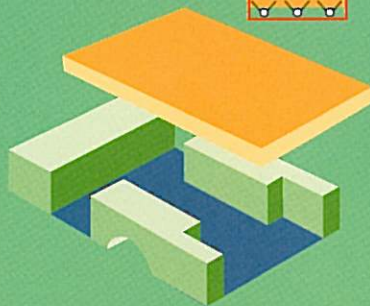

Louxor



Antalia



# Louxor

Essieu freiné  
Axle with brake  
Oploeprem met terugrijautomaat  
Achse mit Bremsvorrichtung und Rückfahrautomatik  
Assle con freno  
Eje con freno

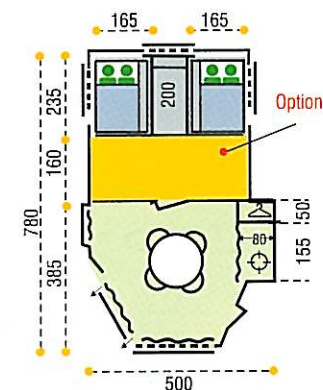
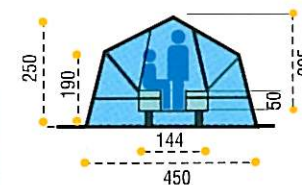
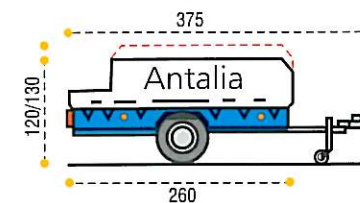
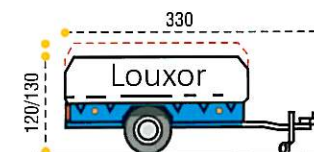

Sommiers à lattes isolés  
Insulated slatted beds  
Isolierte Lattenrostbetten  
Latten bodem  
Letto a doghe  
Somier de láminas



**RACLET**  
*Caravanes Pliantes*



**Jasmin**  
375 kg  
**Santale**  
350 kg

Poids à vide  
Weight (excl. bagage)  
Eigengewicht  
Eigen gewicht  
P.A.V.  
Peso proprio

**Jasmin**  
495 kg  
650 kg (NL)  
**Santale**  
495 kg

Poids total en charge  
Maximum loaded weight  
Max. toelaatbaar gewicht  
Max. Gesamtgewicht  
P.A.P.C.  
Peso total



Jasmin



Jasmin



Santale

# Jasmin

Essieu freiné  
Axle with brake  
Oploeprem met terugrijautomaat  
Achse mit Bremsvorrichtung und Rückfahrautomatik  
Asse con freno  
Eje con freno

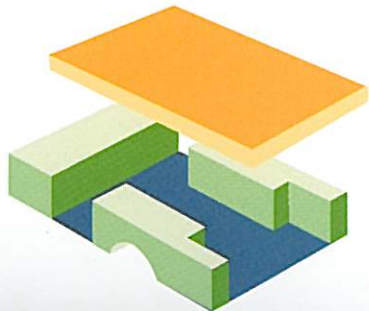
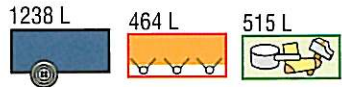
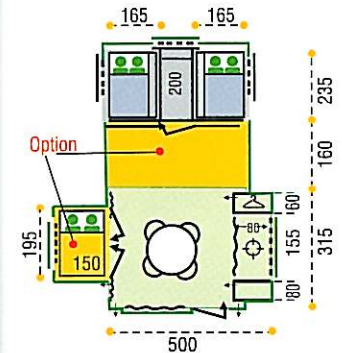
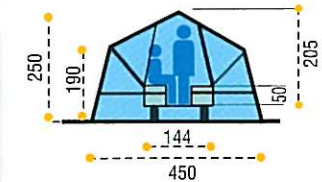
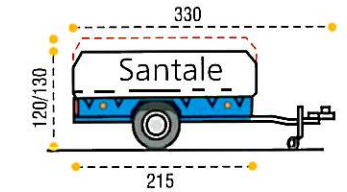
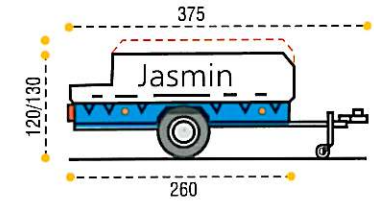



Sommiers à lattes isolés  
Insulated slatted beds  
Isolierte Lattenrostbetten  
Latten bodem  
Letto a doghe  
Somier de láminas



**RACLET**  
Caravanes Plantes



# Solena®

**270 kg**

Poids à vide  
Weight (excl. bagage)  
Eigengewicht  
Eigen gewicht  
P.A.V.  
Peso proprio

**400 kg**

Poids total en charge  
Maximum loaded weight  
Max. toelaatbaar gewicht  
Max. Gesamtgewicht  
P.A.P.C.  
Peso total



16.5 x 6.5-8

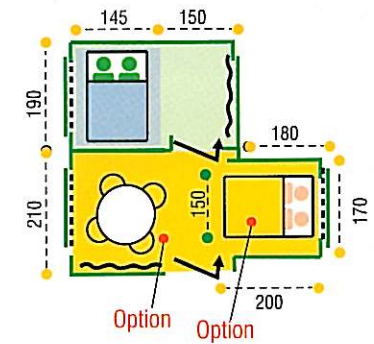
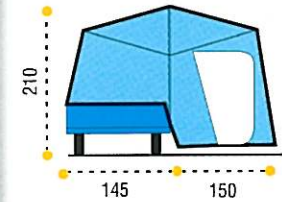
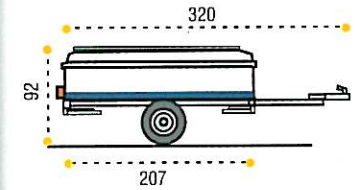

\* 58



940 L

336 L

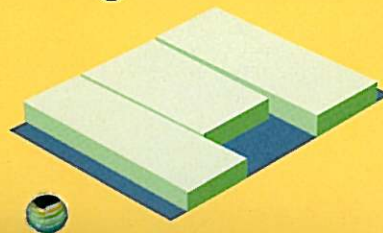

Option  
Optie  
Nach Wahl  
Optional  
Opcional  
Opzione



**Montage ultra rapide sans picquets.**  
**Very quick erecting without pegs.**  
**Ongelovelijk snel op te zetten**  
**Zonder tentharingen**  
**Sehr schneller Aufbau ohne Haringe.**  
**Montaggio ultra rapido senza picchetti.**  
**Montaje ultra-rapido sin piquetas.**



Option Tendelet,  
 Optie Sun awning  
 Nach Wahl Luifel  
 Optional Sonnensegel  
 Opcional Parasole  
 Opzione Visera-parasol  
 180 cm



# Allegra

Essieu freiné  
 Axle with brake  
 Oplooprem met terugrijautomaat  
 Achse mit Bremsvorrichtung und Rückfahrautomatik  
 Assle con freno  
 Eje con freno



135 x 13



**450 kg**

Poids à vide  
 Weight (excl. baggage)  
 Eigengewicht  
 Eigen gewicht  
 P.A.V.  
 Peso proprio

**495 kg**

**650 kg (NL)**

Poids total en charge  
 Maximum loaded weight  
 Max. toelaatbaar gewicht  
 Max. Gesamtgewicht  
 P.A.P.C.  
 Peso total

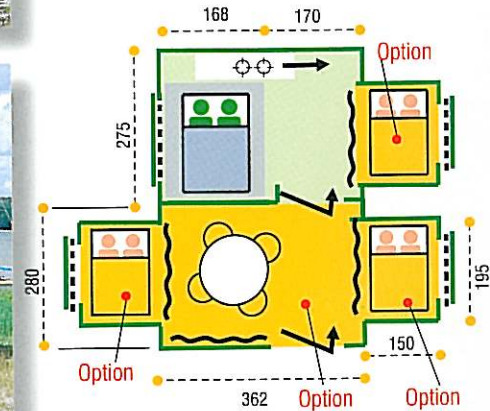
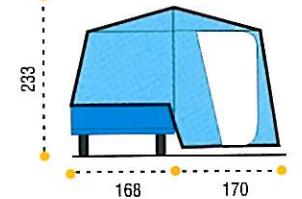
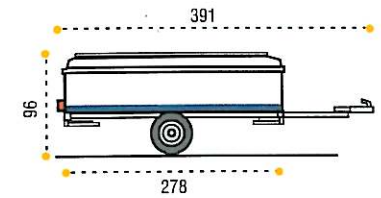

1755 L

725 L

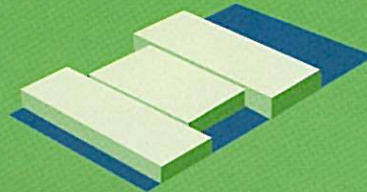



Montage ultra rapide  sans piquets.  
 Very quick erecting without pegs.  
 Ongelovelijk snel op te zetten  
 Zonder tentharingen  
 Sehr schneller Aufbau ohne Haringe.  
 Montaggio ultra rapido senza picchetti.



Option	Tendelet,
Optie	Sun awning
Nach Wahl	Luifel
Optional	Sonnensegel
Opcional	Parasole
Opzione	Visera-parasol
	180 cm



*creazioni Phantasia*



# Quick stop

**380 kg**

Poids à vide  
Weight (excl. bagage)  
Eigengewicht  
Eigen gewicht  
P.A.V.  
Peso proprio

**495 kg**

**650 kg (NL)**

Poids total en charge  
Maximum loaded weight  
Max. toelaatbaar gewicht  
Max. Gesamtgewicht  
P.A.P.C.  
Peso total



Essieu freiné  
Axle with brake  
Oploeprem met terugrijautomaat  
Achse mit Bremsvorrichtung und Rückfahrautomatik  
Assle con freno  
Eje con freno

1238 L

515 L

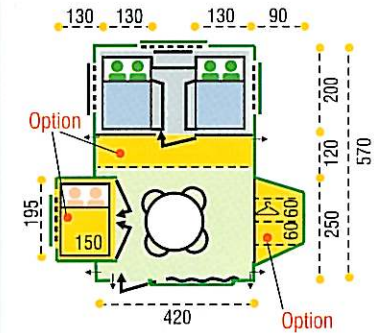
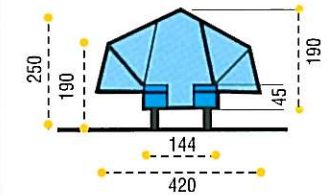
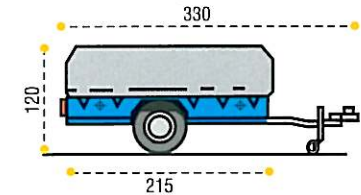
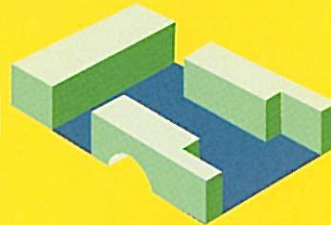



**Montage ultra rapide sans piquets.**  
**Very quick erecting without pegs.**  
**Ongelovelijk snel op te zetten**  
**Zonder tentharingen**  
**Sehr schneller Aufbau ohne Häringe.**  
**Montaggio ultra rapido senza picchetti.**  
**Montaje ultra-rápido sin piquetas.**

Option  
 Optie  
 Nach Wahl  
 Optional  
 Opcional  
 Opzione

Tendelet,  
 Sun awning  
 Luifel  
 Sonnensegel  
 Parasole  
 Visera-parasol  
 160 cm



**RACLET**

*Campings et Plus*



# Globe trotter®



Réfrigérateur  
Refrigerator  
Kühlschrank  
Koelkast  
Frigorifero  
Frigorifico



56 L

Essieu freiné  
Axle with brake  
Oplooprem met terugrijautomaat  
Achse mit Bremsvorrichtung und Rückfahrautomatik  
Assle con freno  
Eje con freno

Option  
Optie  
Nach Wahl  
Optional  
Opcional  
Opzione

Pare-soleil  
Sun awning  
Luifel  
Sonnensegel  
Parasole  
Visera-parasol  
210 cm

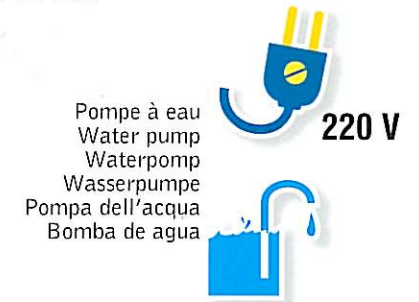

Pompe à eau  
Water pump  
Waterpomp  
Wasserpumpe  
Pompa dell'acqua  
Bomba de agua

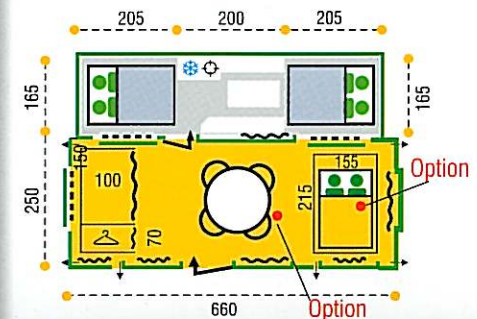
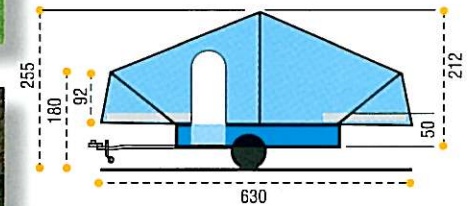
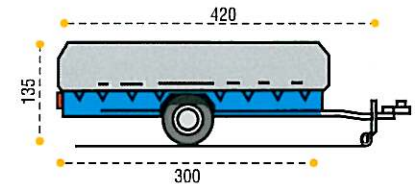

**450 kg**  
Poids à vide  
Weight (excl. baggage)  
Eigengewicht  
Eigen gewicht  
P.A.V.  
Peso proprio

**495 kg**  
**650 kg (NL)**  
Poids total en charge  
Maximum loaded weight  
Max. toelaatbaar gewicht  
Max. Gesamtgewicht  
P.A.P.C.  
Peso total



Super Quick Stop



135x13



2227 L



1148 L



239 L

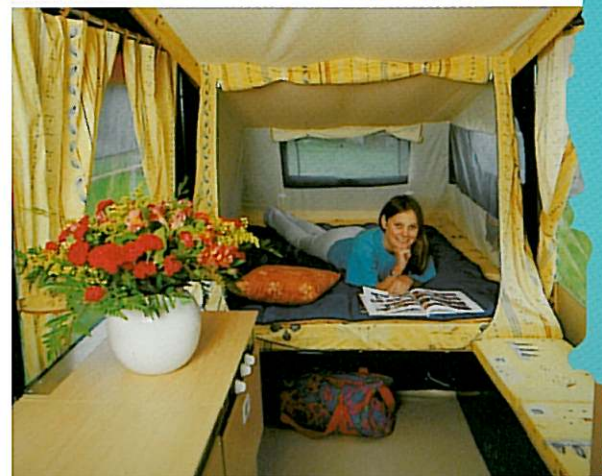
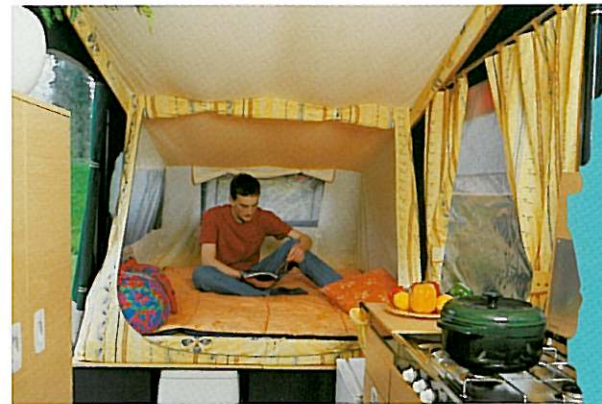
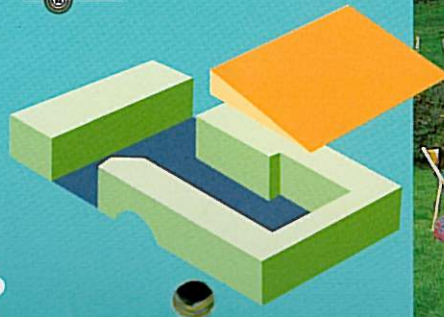





Montage ultra rapide sans piquets.  
Very quick erecting without pegs.  
Ongelovelijk snel op te zetten  
Zonder tentharingen  
Sehr schneller Aufbau ohne Häringe.  
Montaggio ultra rapido senza picchetti.  
Montaje ultra-rápido sin piquetas.



**RACLET**  
*Caravanes Pliantes*

# Equipements Accessoires

1 Coffre sur flèche  
Towbar storage box  
Disselbak  
Porta frigo per timone  
Arcon

Pare-soleil / Sun awning /  
Luifel / Sonnensegel / Parasole/Visera-parasol

2 Santale, Jasmin,  
Louxor, Antalia : 210 cm

3 Minto, Florès, Floreal  
Globe Trotter : 210 cm

4 Solena, Allegra : 180 cm  
Quick Stop : 160 cm

5 Chambre 2 places adaptable sous plateau  
Under-bed inner tent  
Tweepersoons-ondertent  
Zusatzschlaf-oder Staukabinen  
Camera 2 posti adattabili sotto ripiano  
Cuarto de 2 puetos adaptables bajo repisa

6 Galerie / Roof-rack  
Imperial / Gepäckträger  
Portebagagli / Baca

7 Barres porte-tout (2)  
Rack adaptor bars (2)  
Zusatzprofile (2)  
Imperiaal voor fietsdragers (2)  
Barres portatutto (2)  
Barras de techo (2)  
Solena, Allegra

8 Chambre annexe / Bedroom annexe  
Schlafkabine / Slaapcabine  
Habitation / Camera supplementare  
Santale, Jasmin,  
Solena, Allegra, Quick Stop

9 Coffres sous banquettes  
Bench storage lockers  
Bankkasten met veel bergruimte  
Staukästen unter Sitzflächen  
Bauletti sotto panchine  
Cofres bajo los asientos

10 Table / Table / Tafel  
Tisch / Tavola / Mesa

11 Aération chambre double volet  
Ventilated inner tents  
Goede ventilatie mogelijkheden  
Zimmerbelüftung-Doppelvorhänge  
Finestra camera sotto ripiano  
Ventilación habitaciones

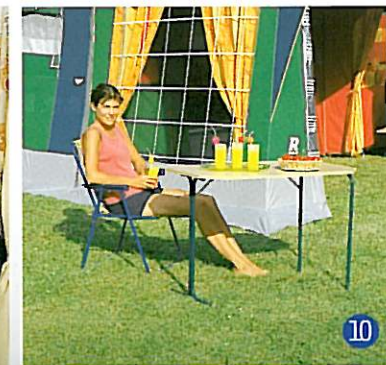
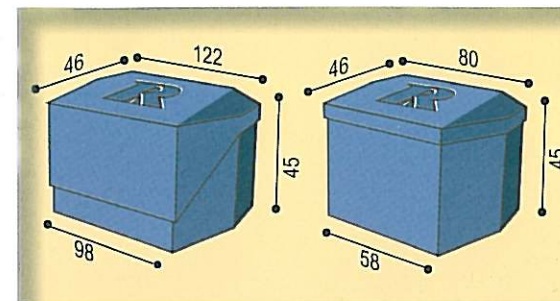

Dosseret banquette  
 Back-rest  
 Rugleuningen  
 Rückenlehnen  
 Intelaiatura  
 Respaldos asientos  
 Santale, Jasmin, Louxor,  
 Antalia, Quick Stop,  
 Globe trotter

Meuble cuisine  
 Kitchen unit  
 Keukenblok  
 Küchenblock  
 Blocco cucina  
 Bloque cocina

13 Florès : 51 L

14 Florès, Solena : 51 L  
 Louxor, Santale,  
 Quick Stop, Globe Trotter : 100 L

15 Jasmin, Antalia : 181 L

16 Floreal : 181 L

17 Allegra : 140 L

Essieu freiné, recul automatique  
 Axle with brake  
 Oplooprem met terugrijautomaat  
 und Rückfahrautomatik  
 Assle con freno  
 Eje con freno

19 Roue jockey / Jockey wheel  
 Telescopisch neuswiel  
 Bugrad / Ruota jockey  
 Rueda jockey

20 Berceaux de garage  
 Storage brackets  
 Kantelbeugels  
 Kippvorrichtung  
 Archi di remessaggio  
 Mensulas de estacionamiento

Les équipements ainsi que les caractéristiques peuvent varier en fonction des pays. / The fittings as well technical data can vary according to each country. / Die Ausstattungen sowie die technischen Angaben können je nach Land variieren. / De uitvoeringen evenals de technische opgaven kunnen per land verschillen. / Los equipos y las características técnicas pueden cambiar de un país a otro. / Le dotazioni e le caratteristiche tecniche potranno variare.



11

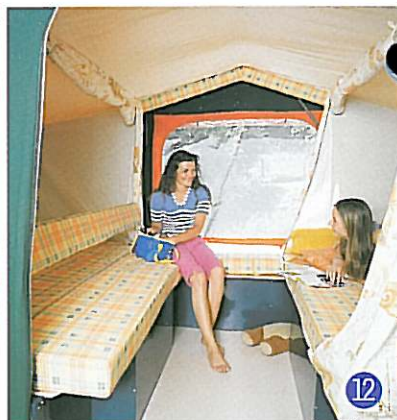

12



13



14



15



16



17

Volume, Volume, inhoud,  
 volumen, volume, volumen

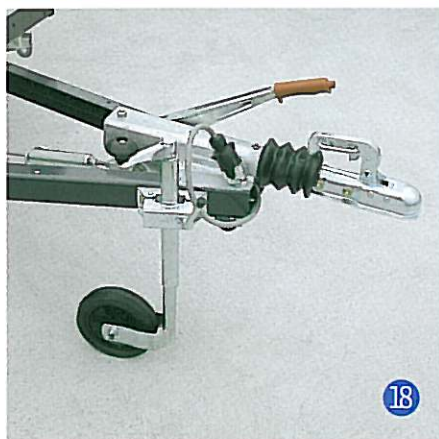

18



19

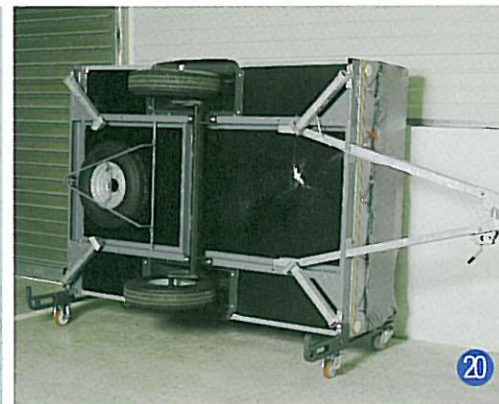

20



total  
 total  
 totaal  
 gesamt  
 totale  
 total



rangement  
 storage  
 opberggruimte  
 verstauen  
 assettamento  
 aparcamiento



sous bâche  
 under cover  
 afdekzeil  
 unter der Plane  
 sotto copertone  
 bajo toldo



# ARMA Clic®

Easy action erecting system  
Fameus opzetsysteem  
Automatischer Aufbau  
Apertura automática  
Apertura automática

# Dépliage ultra rapide



Armature télescopique entièrement solidarisée : ARMAclic est deux fois plus légère qu'une armature acier traditionnelle. Elle se déploie et se replie en un clin d'oeil. Le réglage est fiable et très simple grâce à un astucieux système de bagues. ARMAclic est en aluminium anodisé inaltérable diamètre 28 mm. Système breveté.

Fully inter-connected in dural it unfolds and re-folds again into one piece. International patents

Parapluframe. Gemakkelijk in en uit te vouwen aluminium voortent frame. Het parapluframe is zo eenvoudig, je hoeft niet meer te stoeien met stokken, want alles zit aan elkaar vast en is eenvoudig door één persoon op te zetten. Internationaal gepatenteerd.

Aluminium-gestänge in einem Stück Patentiertes system

Armatura in alluminio interamente unita. Modello brevettato

Armodura aluminio del avance, de uno sola pieza (opcional). Sistema patentado Solena, Allegra, Quick Stop

Notre catalogue ne peut être considéré comme contractuel. Nous nous réservons la possibilité d'apporter toutes modifications que nous jugeons utiles à nos produits.  
Our catalogue cannot be considered as contractually binding. We reserve the right to make any modification we consider necessary to our products.  
Deze folder mag niet als contractueel worden beschouwd. Raclet behoudt zich het recht voor om technische en commerciële verbeteringen door te voeren.  
Unser katalog ist vertraglich nicht bindend. Wir behalten uns das Recht vor, jederzeit für uns nützliche Änderungen vorzunehmen.  
Il nostro catalogo non può essere ritenuto contrattuale, ci riserviamo la possibilità di apportare ogni modifica da noi ritenuta utile ai nostri prodotti.  
Nuestro catalogo no puede estar considerado como carácter contractual. Nos reservamos la posibilidad de anadir toda modificación que sea oportuna.

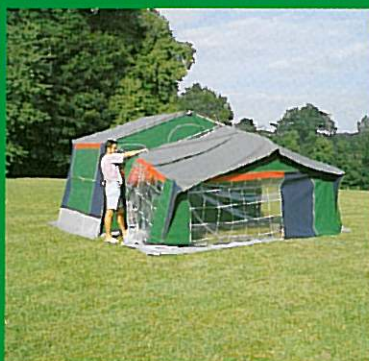
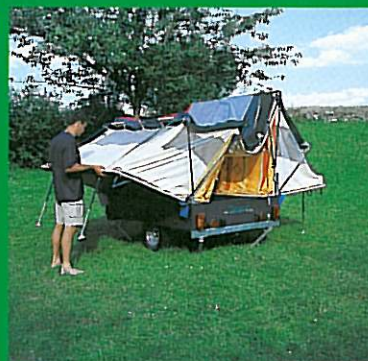
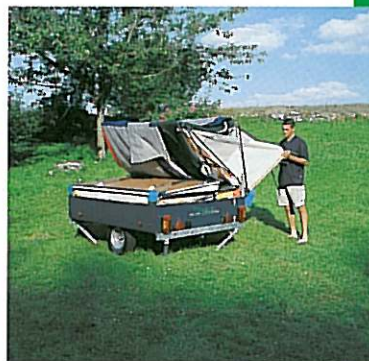

**RACLET**  
*Caravanes Pliantes*

Haut Eclair  
72600 Mamers - France  
Tél 02 43 31 12 30  
Fax 02 43 31 12 31  
contact@raclet.fr

www.raclet.fr