

Publication reserved for use  
only by authorised dealers.

• 2012 • UK

# Product guide

## Carioca • S-Line



*True progress is only* when the advantages of a new technology become for everybody.

Henry Ford



- + INCREASED STRENGTH
- + INCREASED INSULATION
- REDUCED NOISE
- REDUCED DAMAGE



All 2012 models come with a 10 years warranty against leakages



High density **extruded plastic** more strength.

**STYROFOAM\*\*** in all walls. Better soundproofing and thermal insulation of the vehicle.

**Laminated plastic** in the whole perimeter of the walls.

**Outside floor panel protection:** the outer underfloor of the motorcaravan is treated with a **special protective waterproof covering**.

**Floor thickness (75mm)** for superb thermal performance and sound proofing of the vehicle. Fibreglass under the rear overhang (Garage versions) helps prevent against damage from road.

\*\* TM Trademark of The Dow Chemical Company ("Dow") or an affiliated company of Dow  
\* Similar material with the same technical features on some models

# UPHOLSTERIES









**CARIOCA / S-LINE** Luna standard









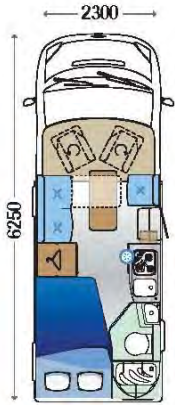
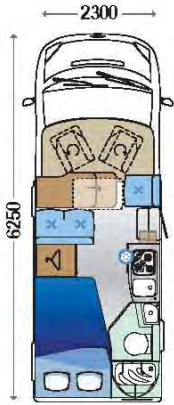
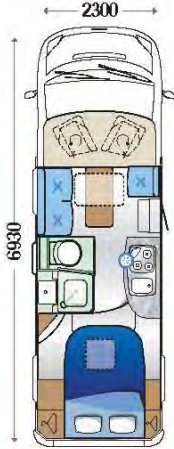
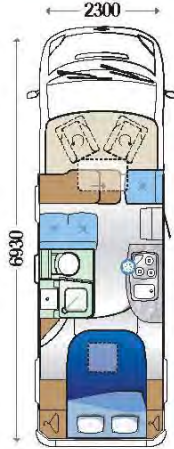

**CARIOCA / S-LINE** Ivory optional



## CARIOCA LOW PROFILE

	200	200 Family	695	695 Family
				
	2	4	2	4
	2	4	2	4
	5	5	5	5
	3500 - 2700	3500 - 2700	3500 - 2840	3500 - 2840
PAG	<b>6</b>	<b>8</b>	<b>10</b>	<b>12</b>
				

# CARIOCA OVERCAB

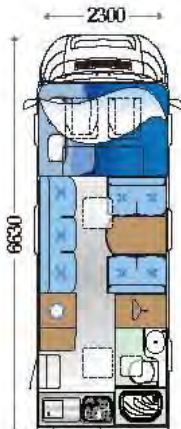
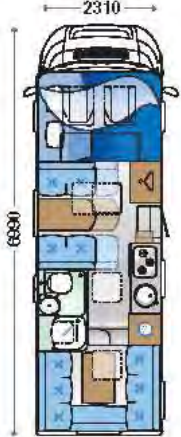
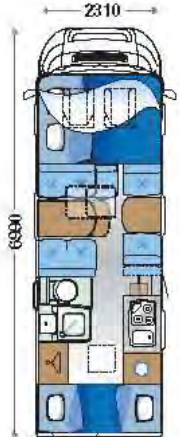
	500	706	707
			
	6	6	7
	5	6	7
	5	6	7
	3500 - 2800	3500/3650 - 3000	3500/3650 - 2910
PAG	<b>14</b>	<b>16</b>	<b>18</b>
			

<b>LEGEND</b>	 Engine	 Berths	 Locker	 Locker Garage motobike
	 Homologated seats	 Dining places	 Maximum technically permissible weight / Weight unladen	 Locker Garage bike

# Standard Features

# Carioca 200

LOW PROFILE



- Compact dimensions 6.2 m
- Panoramic skylight
- LED lighting
- Mini oven with grill

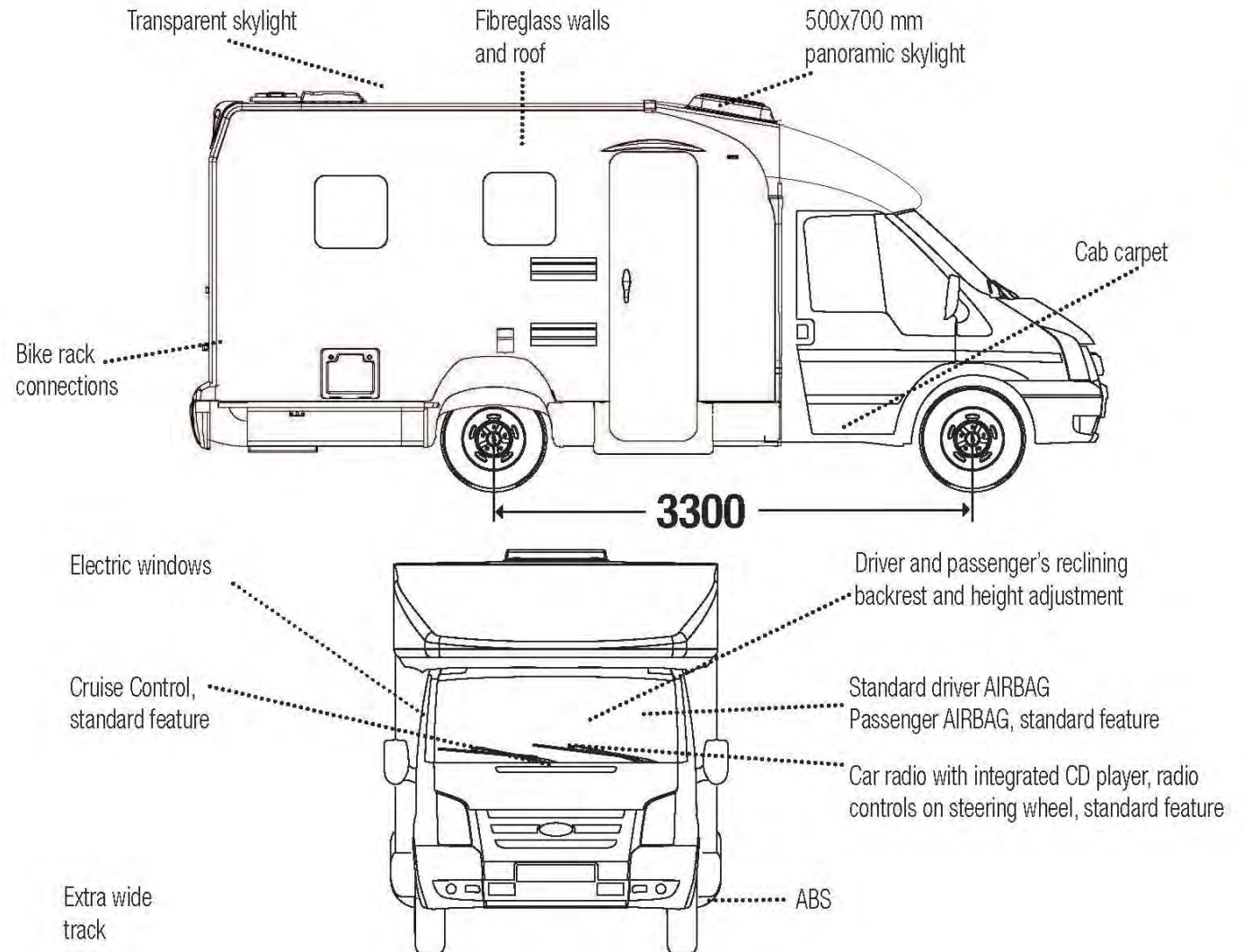

2.2 TDCI

Comfort Pack



Clima Pack



 Standard  Optional



Luna



Ivory



## Carioca 200



Ford 2.2 TDCi  
KW(hp)125/140



2



2



5



970x420 mm



970x420 mm  
locker under bed

Double bed with slatted base that can be raised  
for easy access to the storage area that is also  
accessible from outside

500x700 mm  
panoramic skylight

6250

Washroom  
with separate  
shower and  
rigid shower  
door

Washroom  
skylight and  
window

Cooker top and sink  
integrated with glass  
cover

Minioven with grill

LED lighting

Self closing kitchen  
drawers

Extension to worktop

Courtesy LED lighting

Swivel seats with  
covers

2300

2010x1300(1000)

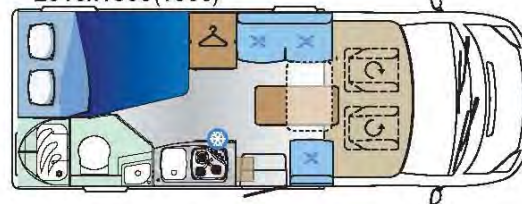

Clean water tank capacity / wastewater /  
Chemical WC 100 / 105 / 17 l.

Standard heating  
Gas combi 4000W

# Standard Features

# Carioca 200 Family

LOW PROFILE



- Compact dimensions 6.2 m
- Panoramic skylight
- LED lighting
- Mini oven with grill

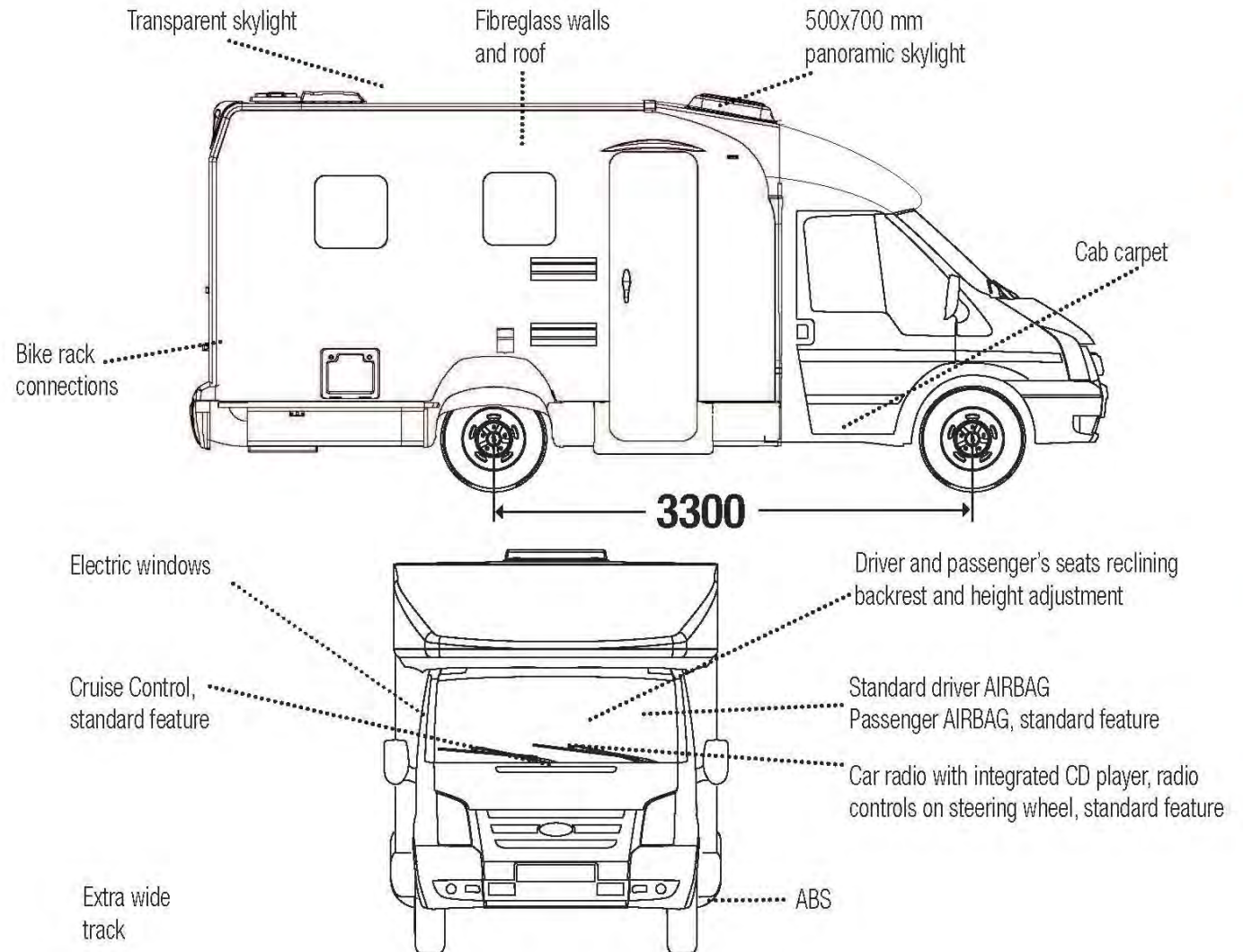

2.2 TDCI

Comfort Pack 

Clima Pack 

 Standard  Optional





Luna



Ivory



## Carioca 200 Family



Ford 2.2 TDCi  
KW(hp)125/140



4



4



5



970x420 mm

970x420 mm  
locker under bed

Double bed with slatted base that can be raised for easy access to the storage area that is also accessible from outside

500x700 mm  
panoramic skylight

6250

Washroom  
with separate  
shower and  
rigid shower  
door

Washroom  
skylight and  
window

Cooker top and sink  
integrated with glass  
cover

Minioven with grill

LED lighting

Self closing kitchen  
drawers

Extension to worktop

Courtesy LED lighting

Swivel seats with  
covers

2300



2010x1300(1100)



2160x1110(930)

Clean water tank capacity / wastewater /  
Chemical WC 100 / 105 / 17 l.

Standard heating  
Gas combi 4000W

# Standard Features

# Carioca 695

LOW PROFILE



- Panoramic skylight
- LED lighting
- Mini oven with grill

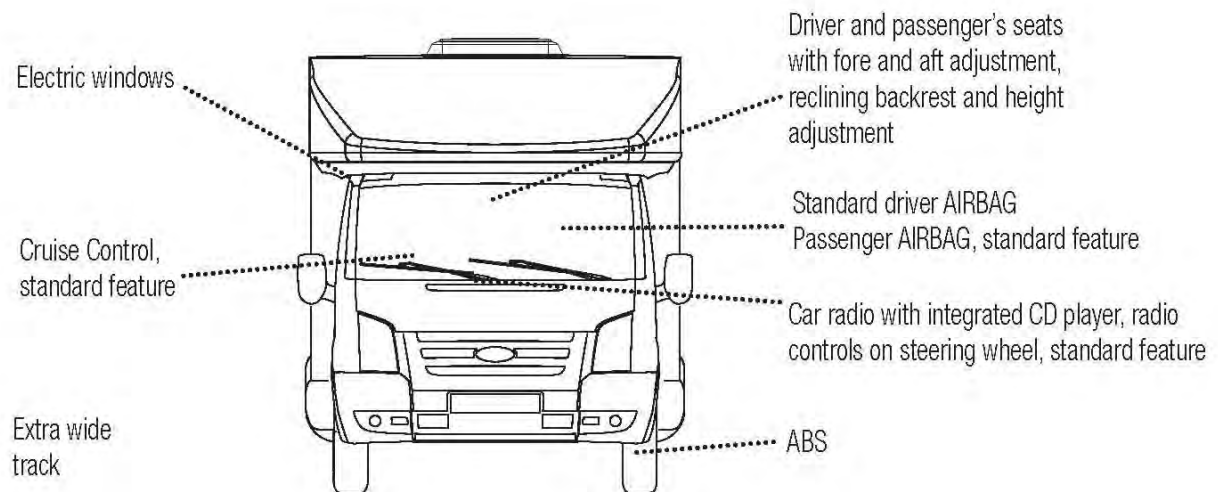
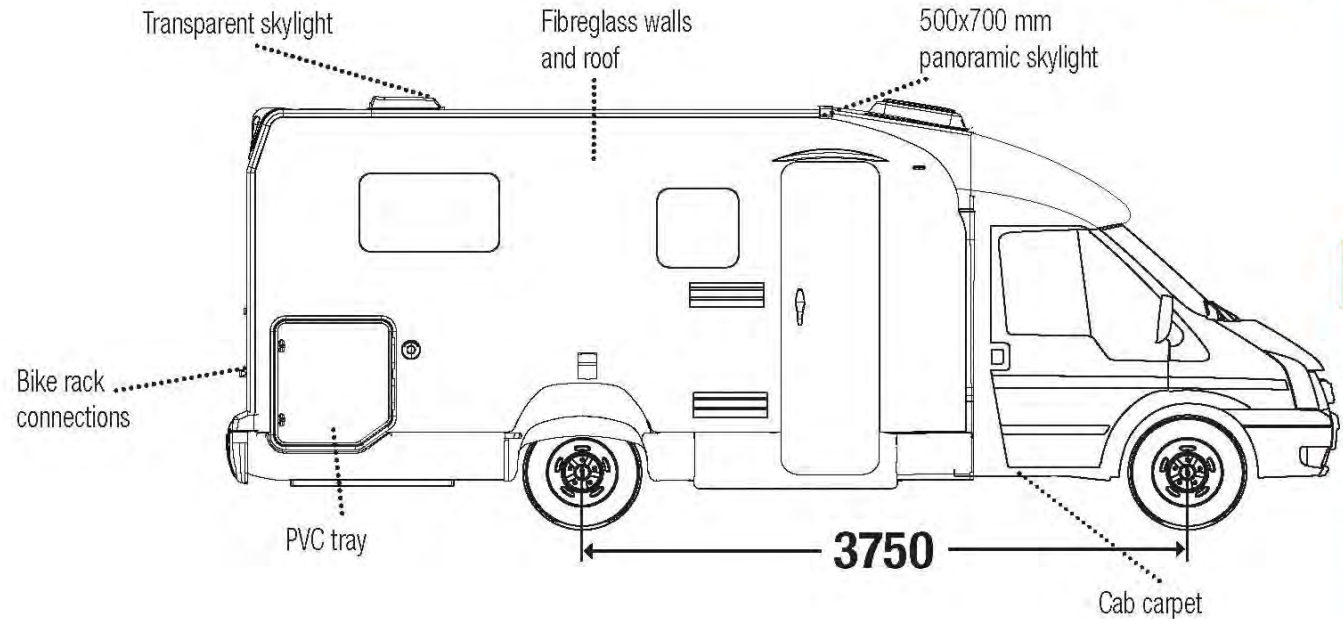

2.2 TDCi

Comfort Pack



Clima Pack



 Standard  Optional



## Carioca 695

Ford Transit  
2.2 TDCi  
KW(hp)125/140



2



2



5



720x770 mm  
420x600 mm

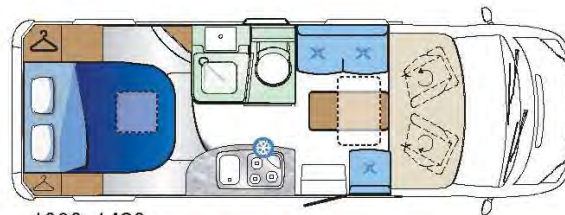
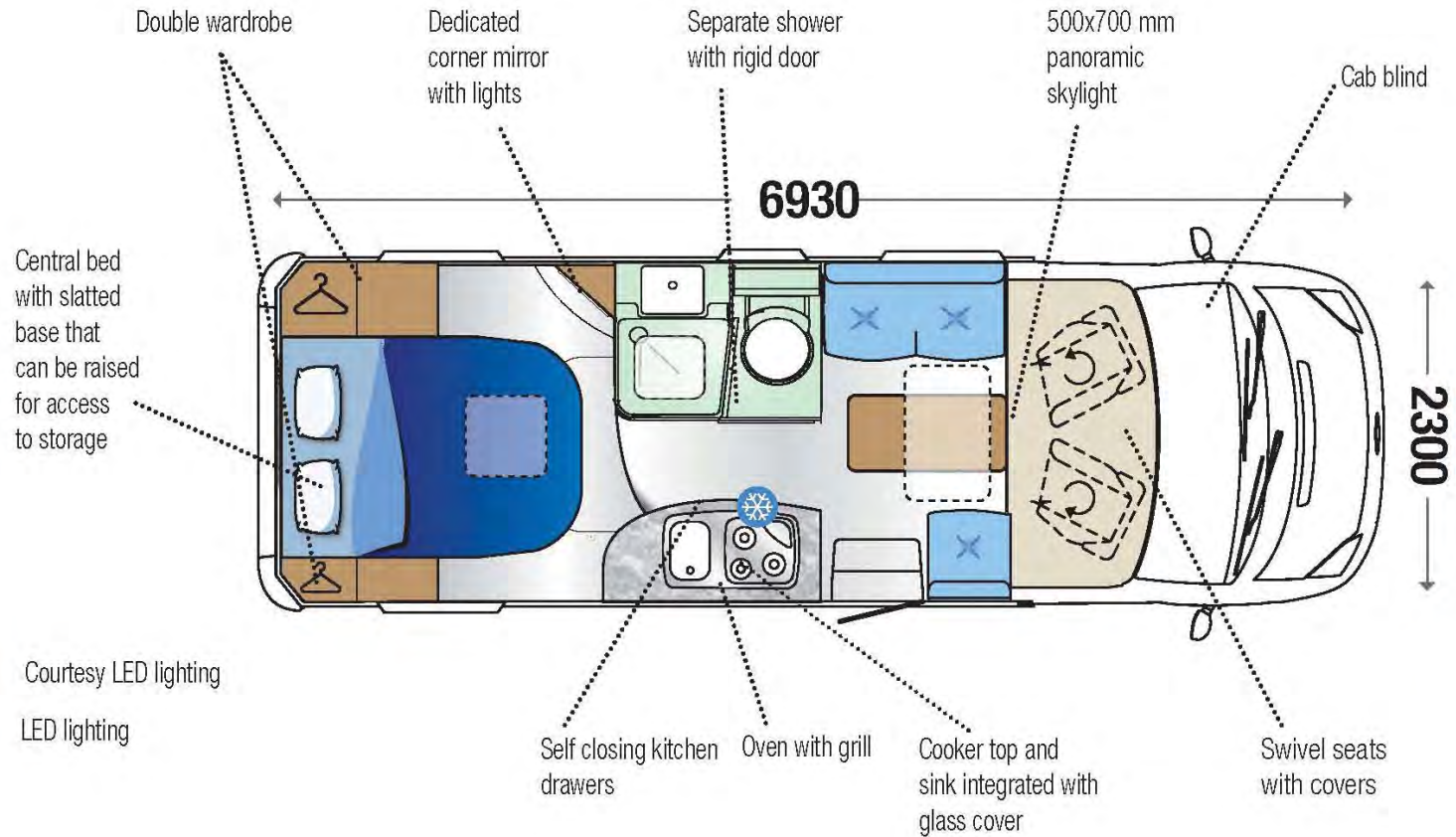

Clean water tank capacity / wastewater /  
Chemical WC 100 / 90 / 17 l.

Standard heating  
Gas combi 4000W

# Standard Features

# Carioca 695 Family

LOW PROFILE



- Panoramic skylight
- LED lighting
- Oven with grill

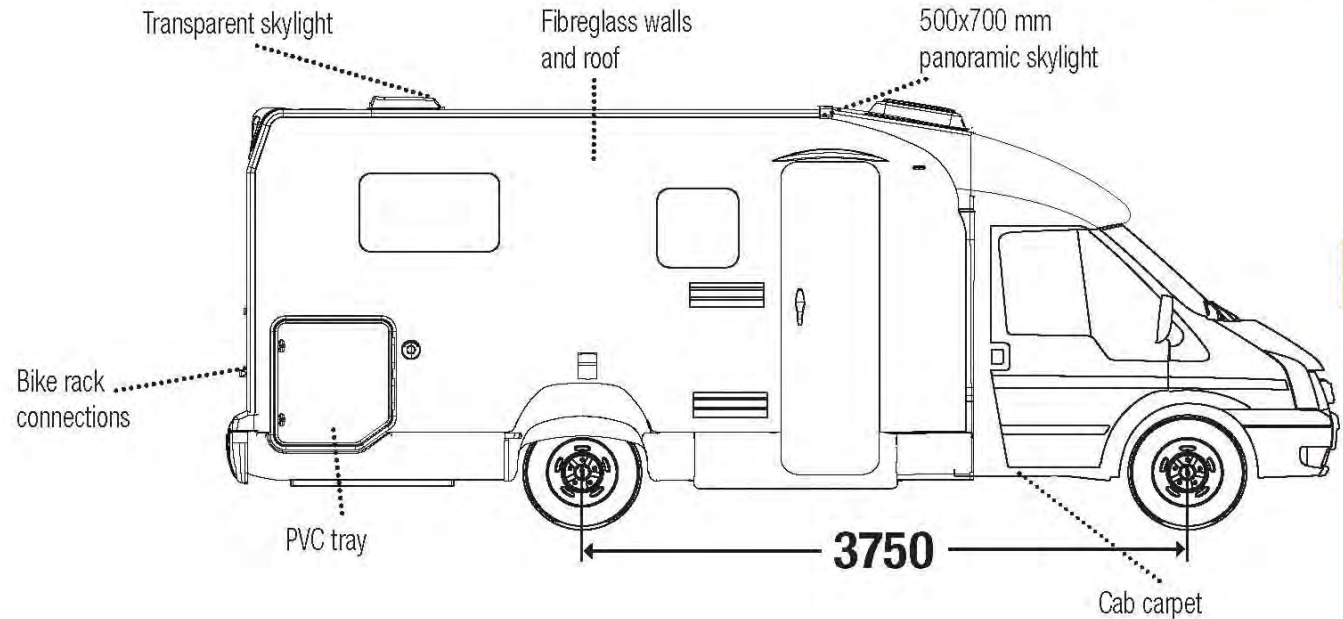

12

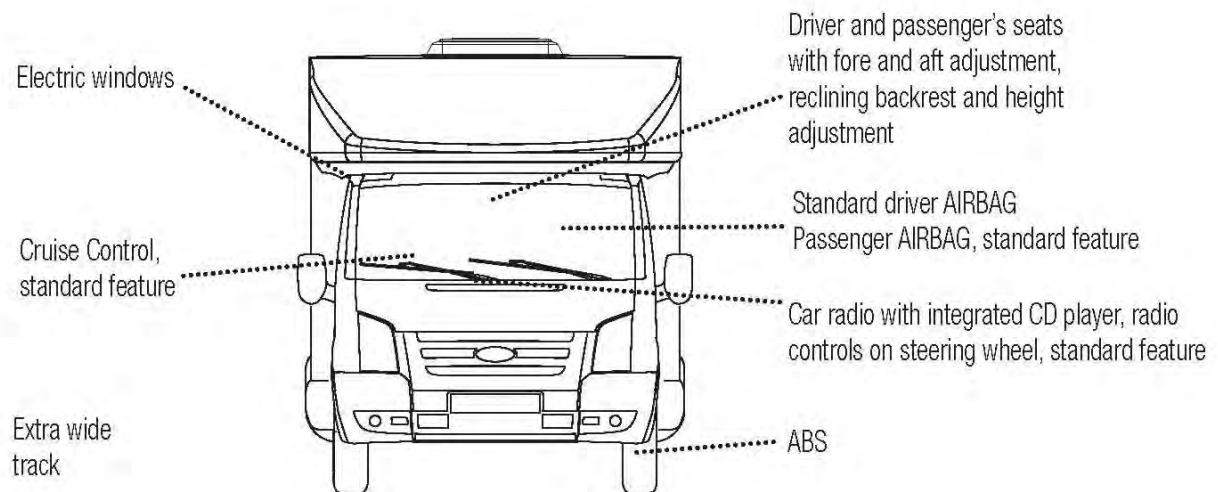

2.2 TDCi

Comfort Pack 

Clima Pack 

 Standard  Optional



## Carioca 695 Family

	Ford Transit 2.2 TDCi KW(hp)125/140
	4
	4
	5
	720x770 mm 420x600 mm

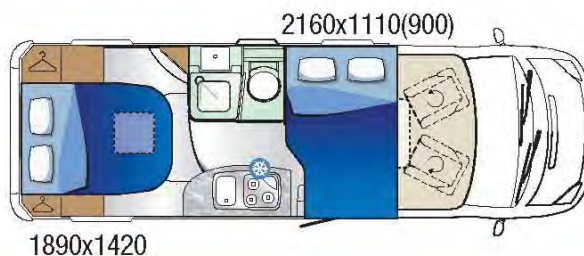
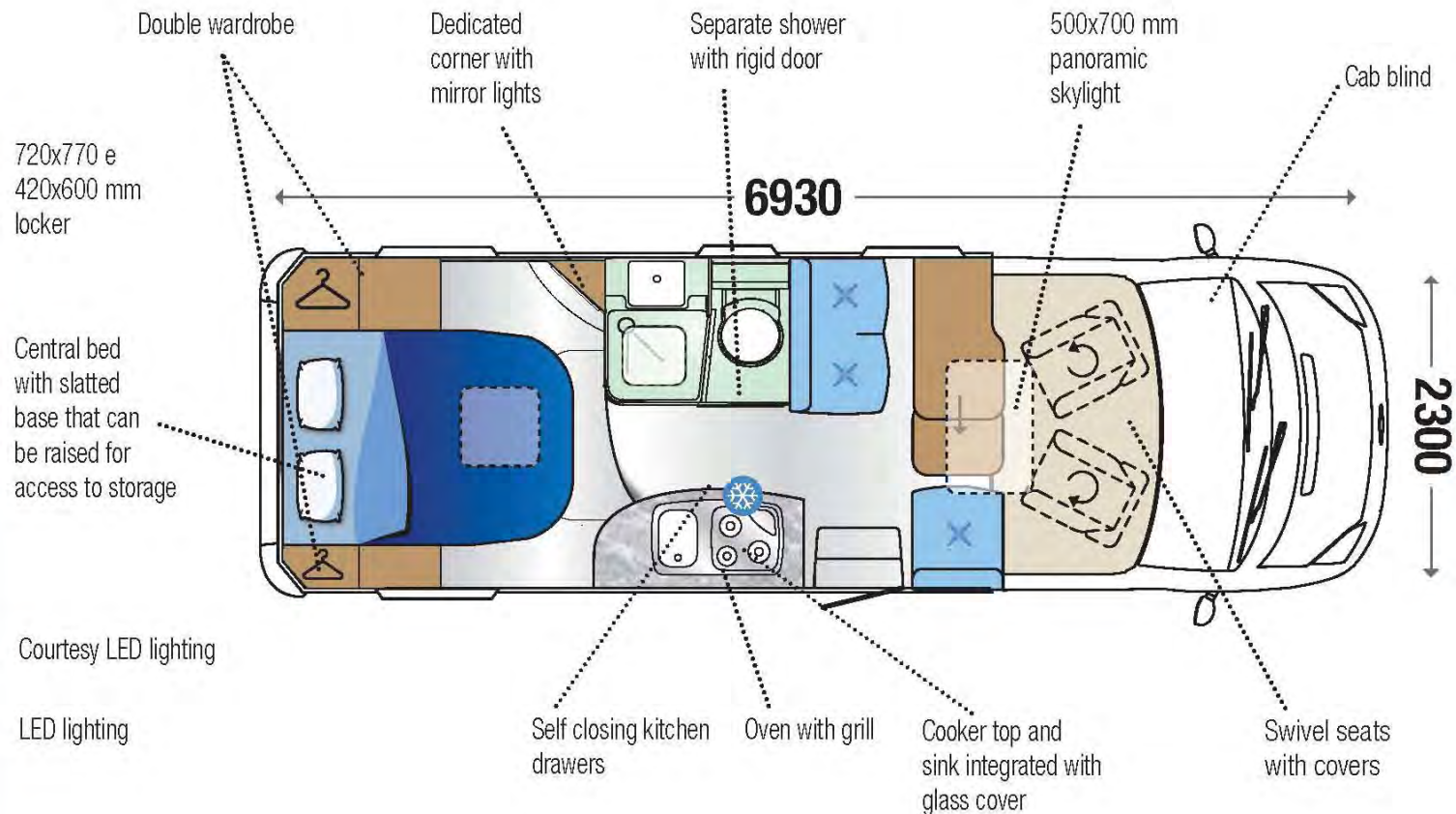

Clean water tank capacity / wastewater /  
Chemical WC 100 / 90 / 17 l.

Standard heating  
Gas combi 4000W

# Standard Features

# Carioca 500

OVERCAB



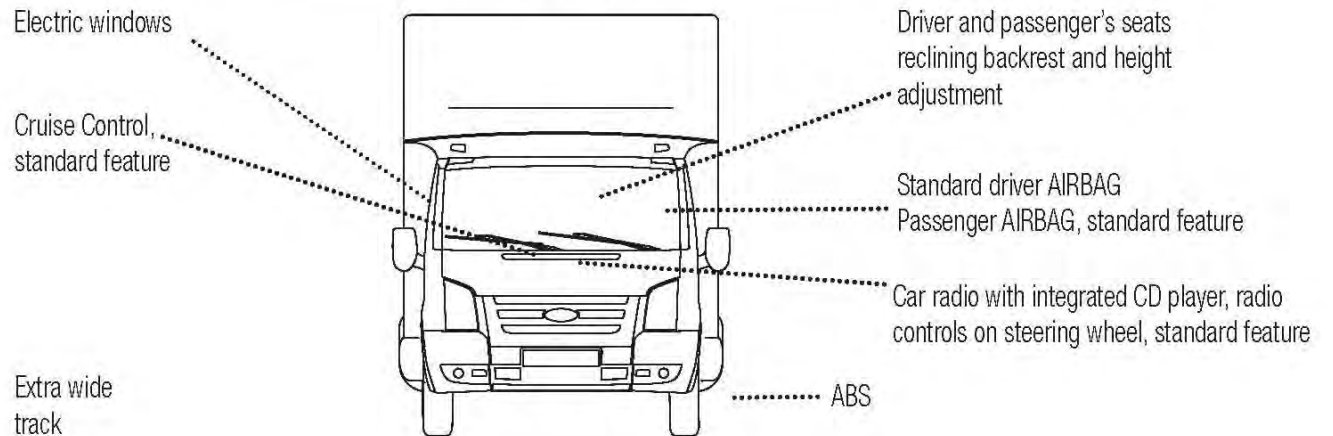
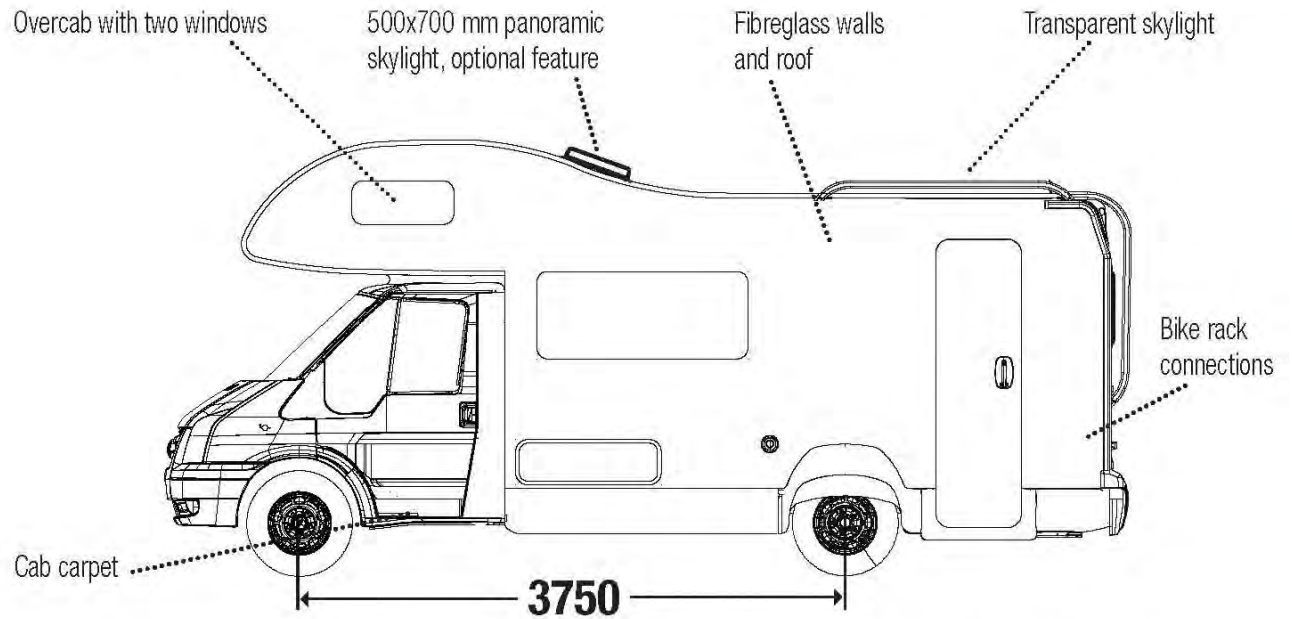

- Panoramic skylight
- LED lighting
- Oven with grill



2.2 TDCi

Comfort Pack 

Clima Pack 

 Standard  Optional



Luna

Ivory

## Carioca 500

Ford Transit  
2.2 TDCi  
KW(hp)125/140



6

5

6

970x280 mm

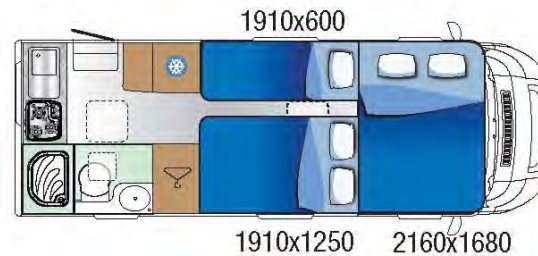
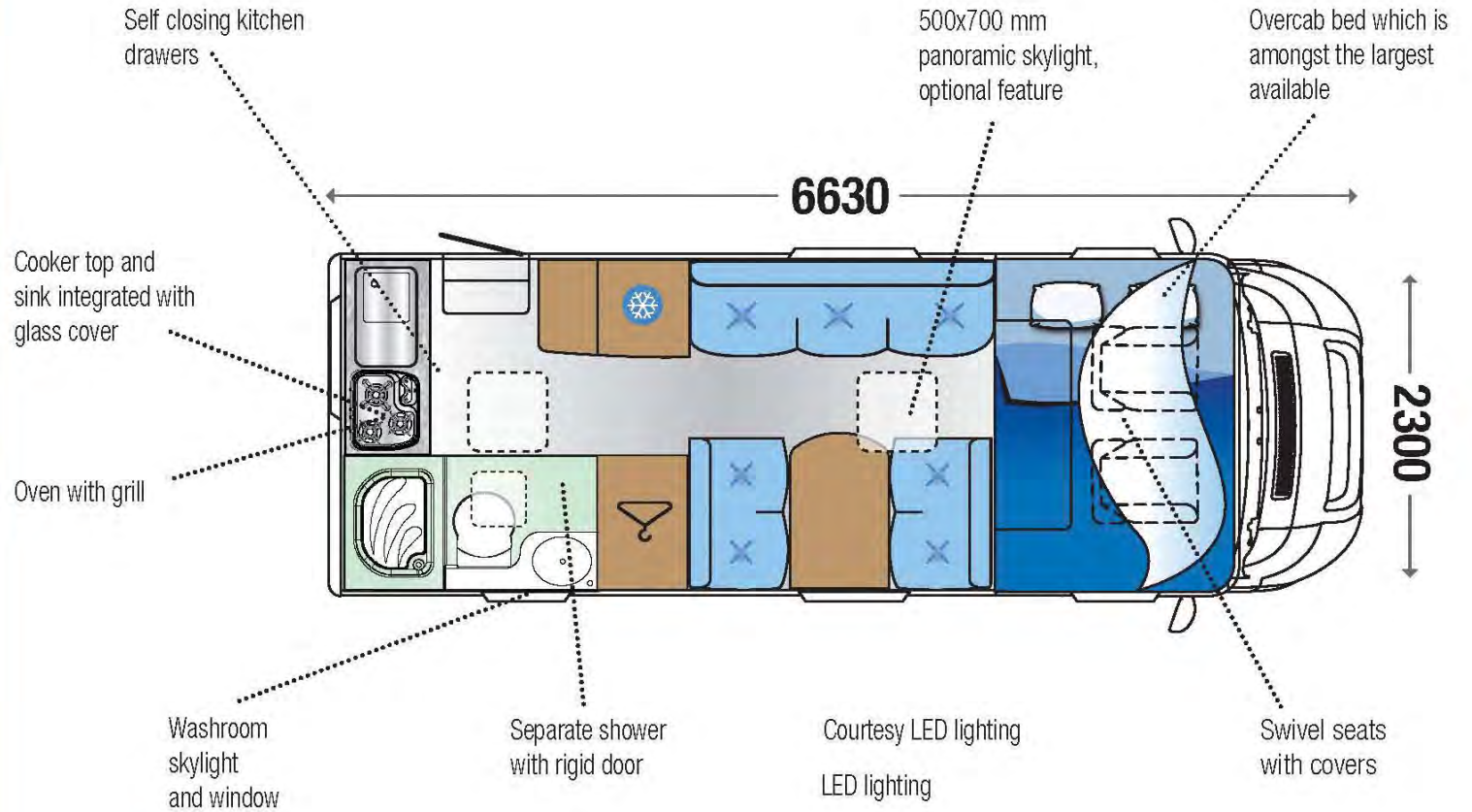

Clean water tank capacity / wastewater /  
Chemical WC 100 / 105 / 17 l.

Standard heating  
Gas combi 4000W

# Standard Features

# Carioca 706

OVERCAB



- Rear dinette up to 6 seats
- 160-Litres maxi fridge
- Under 7 metres
- LED lighting
- Oven with grill

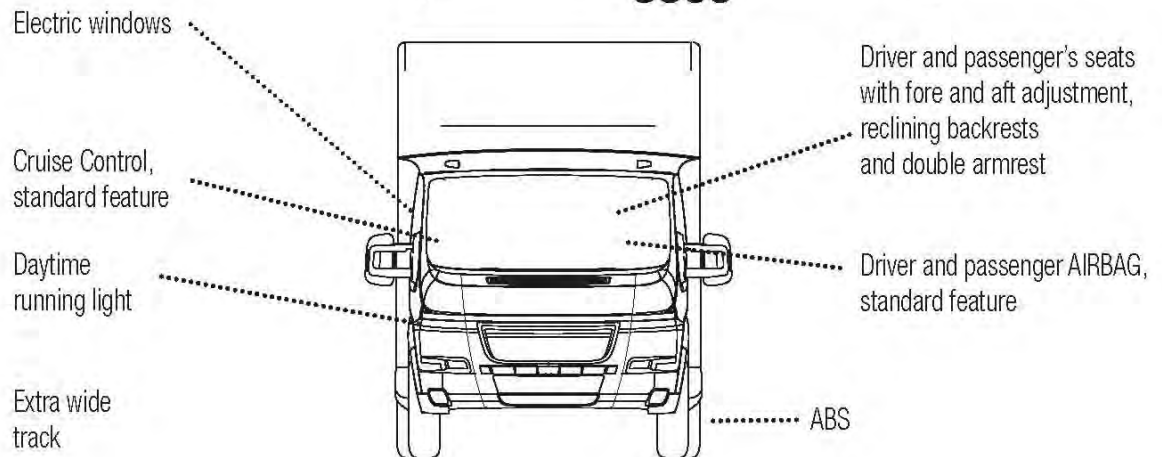
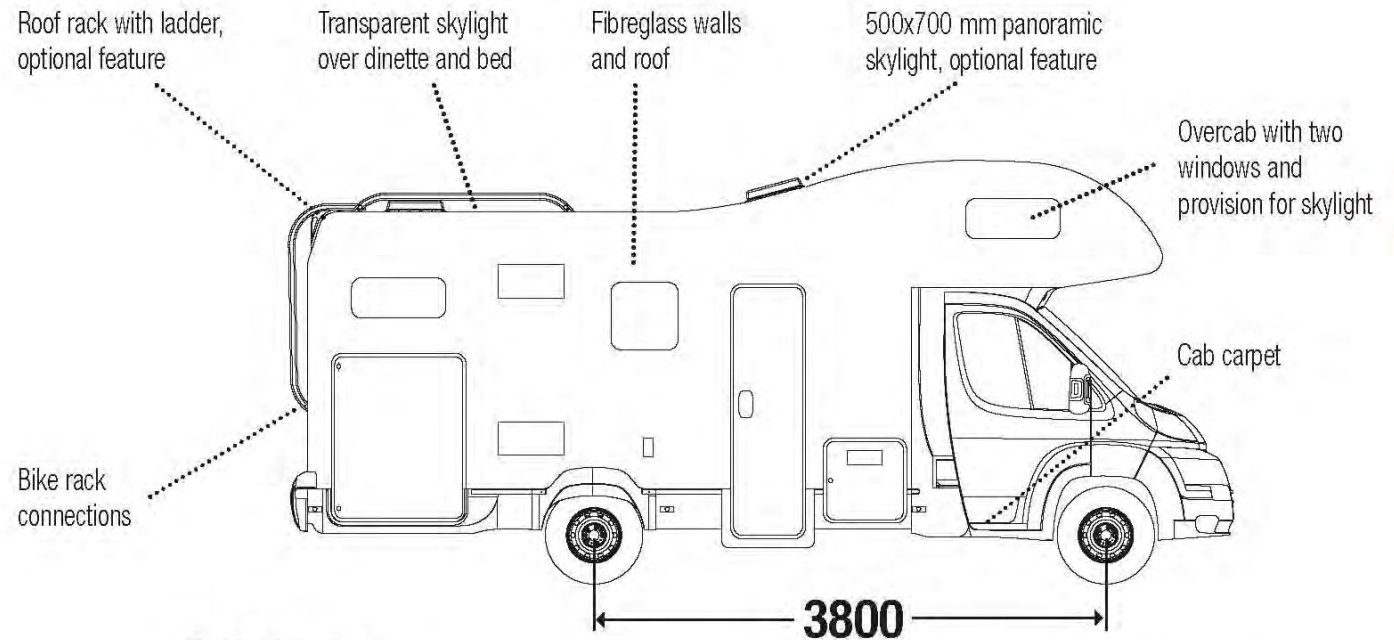

2.3MJ

Comfort Pack	●
Clima Plus Pack	◻
Automatic Pack	◻

● Standard ◻ Optional





Luna

Ivory

## Carioca 706



Fiat Ducato 250  
2.3MJ - 130HP - 35  
2.3MJ - 150HP - 35



6



6



6 (front)  
7 (rear)



970x580 mm (x2)

Courtesy LED lighting



Washroom with separate shower and rigid shower door

Washroom skylight and window

Table and dinette extension for up to 6 seats

Overcab bed which is amongst the largest available, 2160x1680 mm

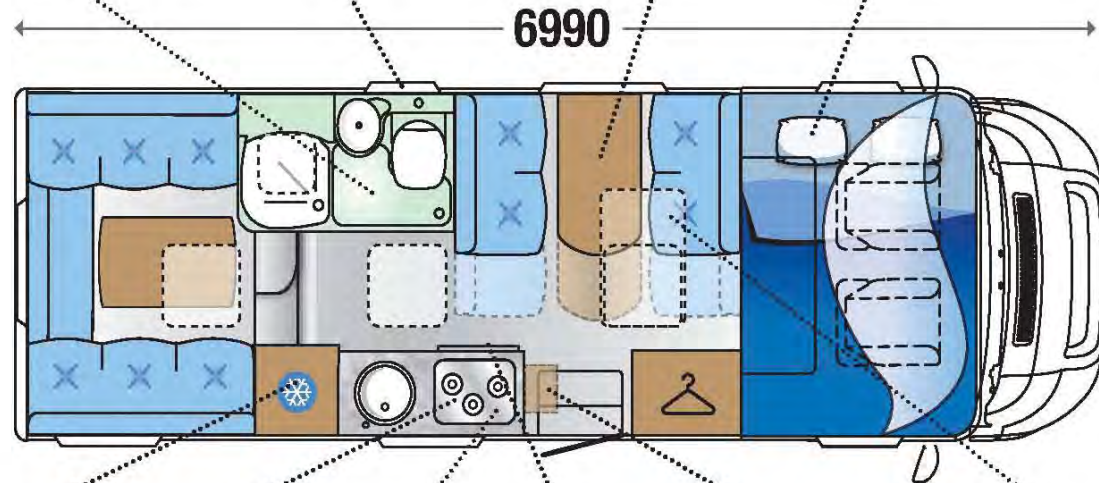

160 l. trivalent fridge, optional feature

Cooker top with three burner hob and glass cover

Oven with grill

Self closing kitchen drawers

Extension to worktop  
LED lighting

500x700 mm panoramic skylight, optional feature

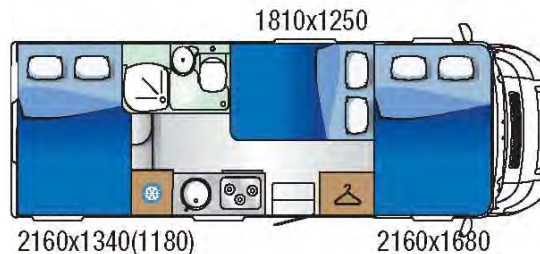

Clean water tank capacity / wastewater / Chemical WC 105 (50) / 108 / 17 l.

Standard heating  
Ebersprecher Diesel oil 3500W

# Standard Features

# Carioca 707

- 7 berths
- 7 seats at the table
- Under 7 metres
- LED lighting
- Oven with grill

OVERCAB

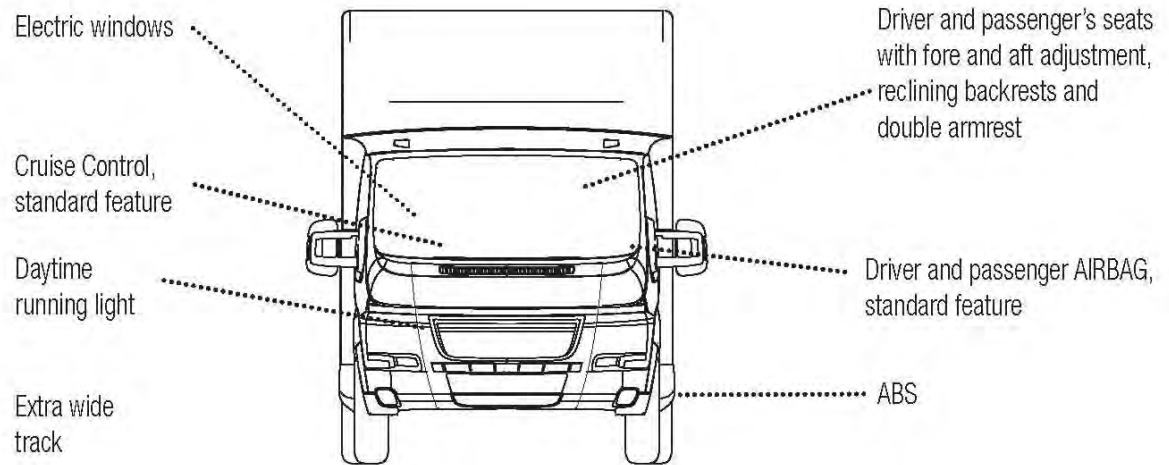
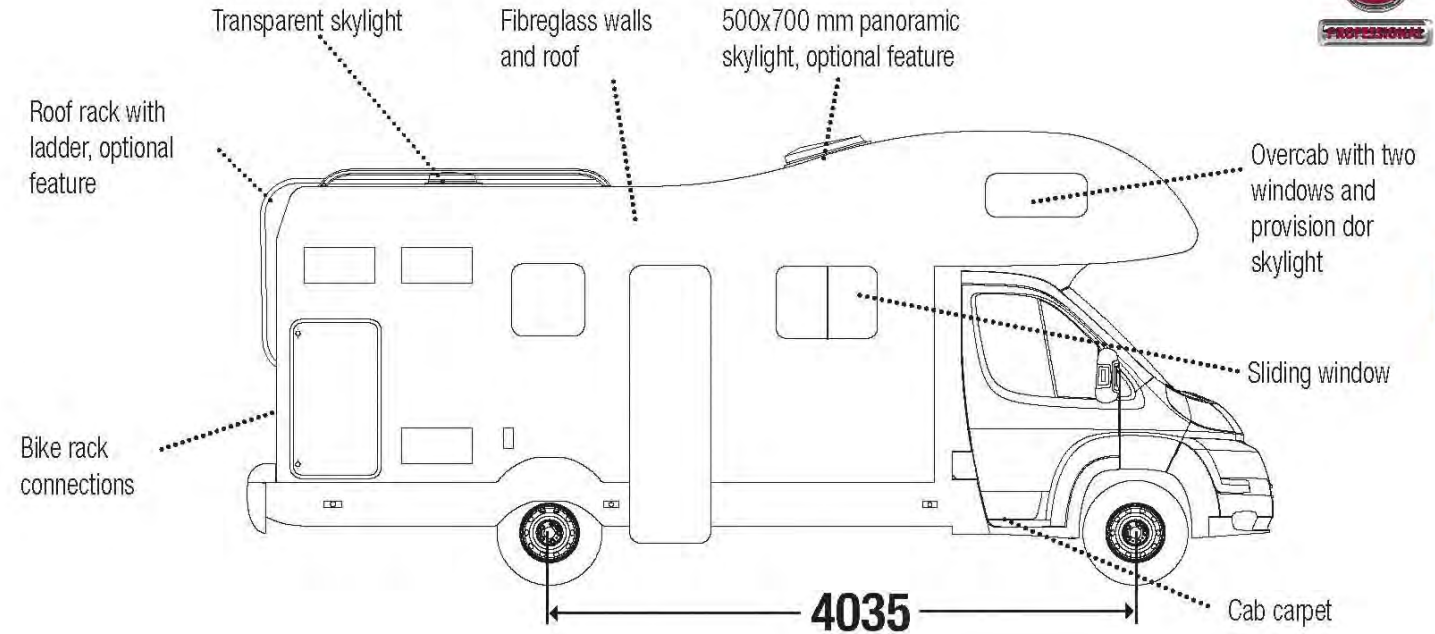

2.3MJ

Comfort Pack	●
Clima Plus Pack	◻
Automatic Pack	◻

● Standard ◻ Optional



Luna



Ivory



## Carioca 707



Fiat Ducato 250  
2.3MJ - 130HP - 35  
2.3MJ - 150HP - 35



7



7



7



1070x600 mm (x2)

Washroom with separate shower and rigid shower door

Washroom skylight

Table and dinette extension for up to 7 seats

500x700 mm panoramic skylight, optional feature

Overcab bed which is amongst the largest available, 2160x1610 mm

Bunk beds with some of the largest sizes in its class 2160x800 mm

160 l. trivalent fridge, optional feature

Locker 1070x600 mm

Cooker top with three burner hob and glass cover

Oven with grill

Self closing kitchen drawers

Folding kitchen top extension

Sliding dinette front seats for maximum confort

LED lighting

Courtesy LED lighting

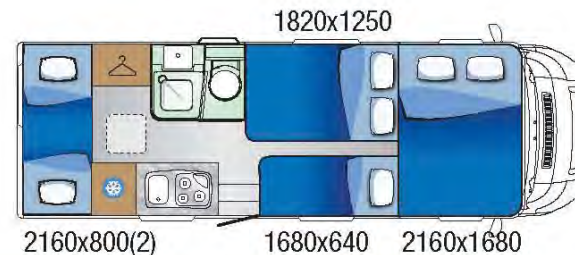

6990

2310

19

Clean water tank capacity / wastewater / Chemical WC 105 / 105 / 17 l.

Standard heating  
Webasto Diesel oil 3500W

# MECHANICAL FITTINGS



## **Comfort Pack:** D12-01

Wide track, spare wheel, special camping tyres, central cab locking with remote control, power windows, ABS, driver and passenger's AIRBAG, passenger and driver's seats with fore and aft adjustment, height-adjustable driver's seat, colour coded bumpers, cruise control, Daytime running lights.

## **Clima Plus Pack:** F12-01

double rear electric view mirrors, air conditioning

## **Automatic Pack:** F12-01

automatic gearbox, leather steering wheel and gearshift knob.

NOTES: The standard FIAT chassis has a 60 litre fuel tank with a view to increasing payload while still guaranteeing high running autonomy.



## **Comfort Pack:** D12-01

Camping suspension, spare wheel, central cab locking, power windows, athermic windows, height-adjustable driver and passenger's seats, reclining backrest and height-adjustable seat, cruise control, trip computer, driver and passenger AIRBAG, ABS, car radio with integrated CD player, radio controls on steering wheel.

## **Clima Plus Pack:** D12-01

Air conditioning, rear electric view mirrors.



500x700 mm panoramic skylight, standard feature for low profile



Cooker top with three burner hob and glass cover



Rear bed access steps with storage space



Wooden Washroom



Oven with grill



Washroom with separate shower and rigid shower door (mod.695, 695 Family, 707)



Overcab bed which is amongst the largest available



Swivel seats with covers



Gloss laminated table and kitchen work top



Courtesy LED lighting



LED lighting



Table and dinette extension for up to 6 seats (mod. 706) or 7 seats (mod. 707)



Rigid shower door, standard feature











Fridge with curved door 160 l. (optional feature mod. 706)







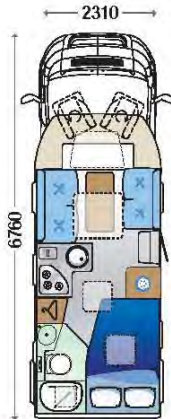
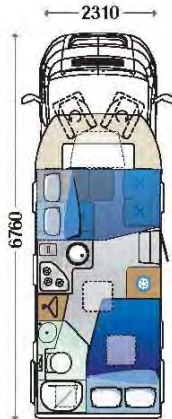
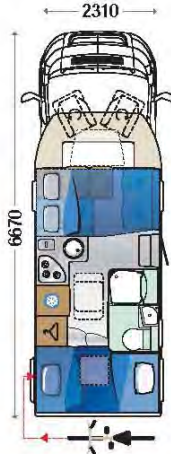

Upholstery in eco-leather, optional feature



Control unit with liquid crystal display and membrane controls

	670	670 Family	680 Family
			
	2	4	4
	2	6	6
	6	6	6
	3500/3650 - 3040(2.3MJ)	3500/3650 - 3040(2.3MJ)	3500/3650 - 2990(2.3MJ)
PAG	<b>24</b>	<b>26</b>	<b>28</b>
			

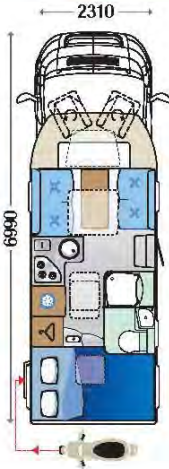
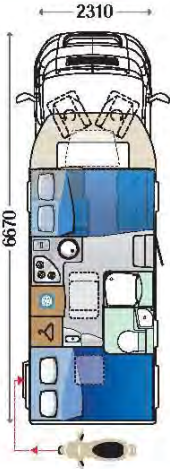
	700	700 Family
		
	2	4
	2	6
	6	6
	3500/3650 - 3080	3500/3650 - 3080
PAG	<b>30</b>	<b>32</b>
		

<b>LEGEND</b>	 Engine	 Berths	 Locker	 Locker Garage motobike
	 Homologated seats	 Dining places	 Maximum technically permissible weight / Weight unladen	 Locker Garage bike

# Standard Features

# S-Line 670

- With SKY DOME (900x800)
- OPEN SKY panoramic roof
- LED lighting
- Oven with grill

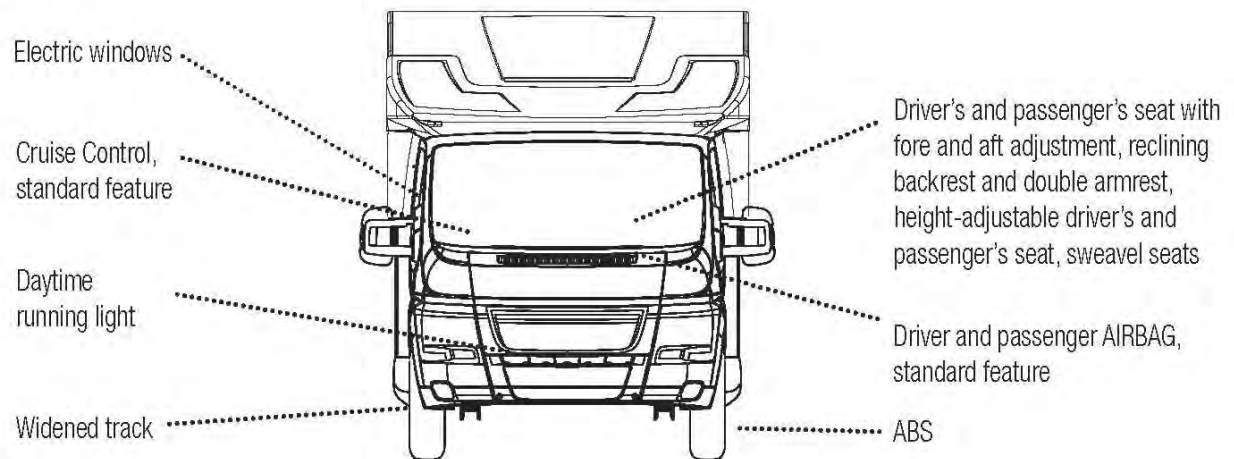
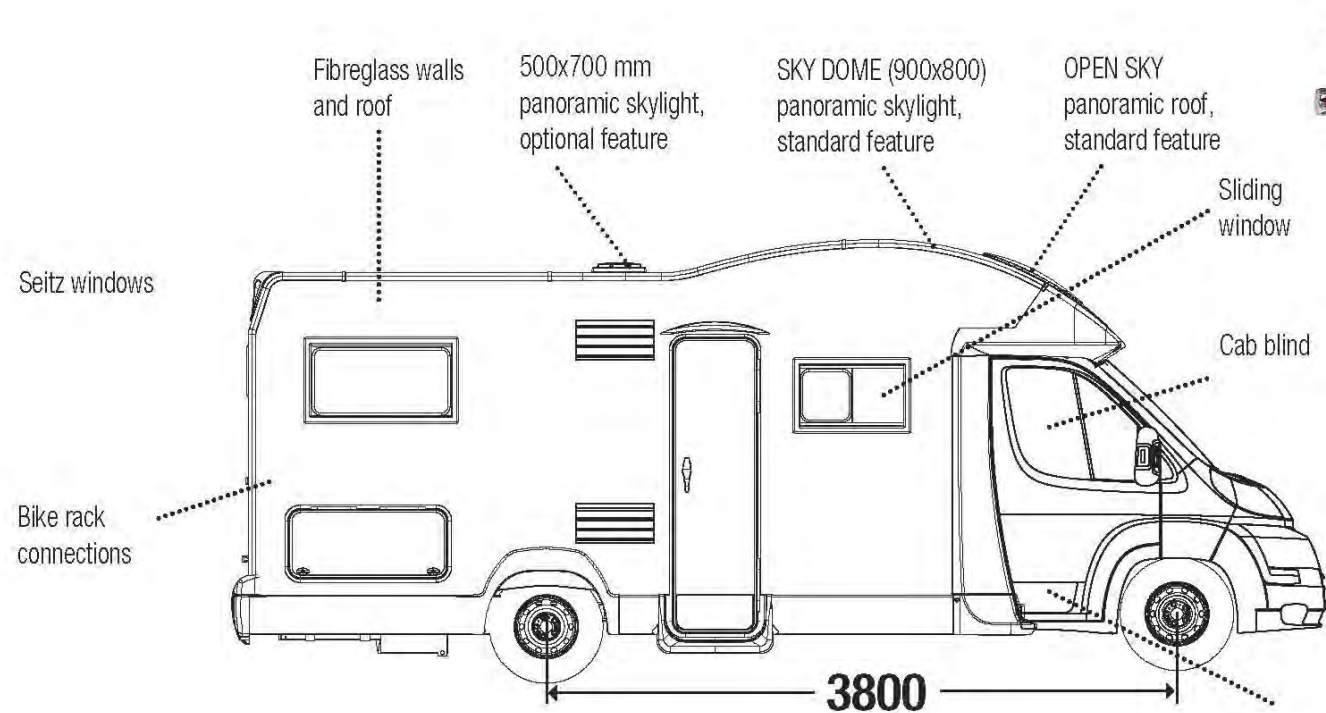

2.3MJ

Comfort Pack	●
Clima Plus Pack	◻
Automatic Pack	◻

● Standard ◻ Optional





Luna



Ivory



## S-Line 670



Fiat Ducato 250  
2.3MJ - 130HP - 35  
2.3MJ - 150HP - 35



2



2



6



970x420 mm

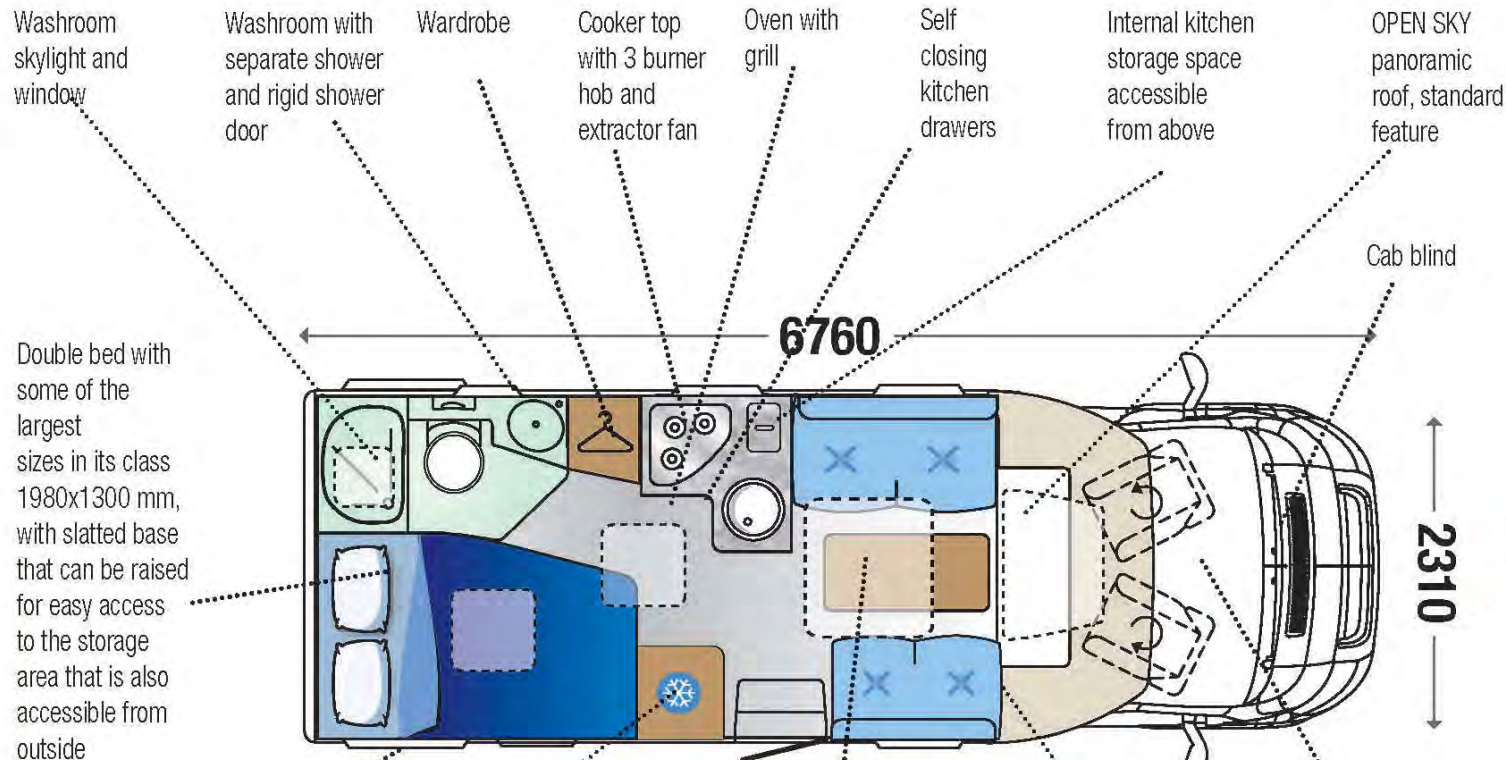

Clean water tank capacity / wastewater /  
Chemical W 100 / 105+50 / 17,5 l.

Standard heating  
Gas combi 4000W

# Standard Features

# S-Line 670 Family

- L-shaped kitchen
- 150-Litres maxi fridge
- LED lighting
- Oven with grill

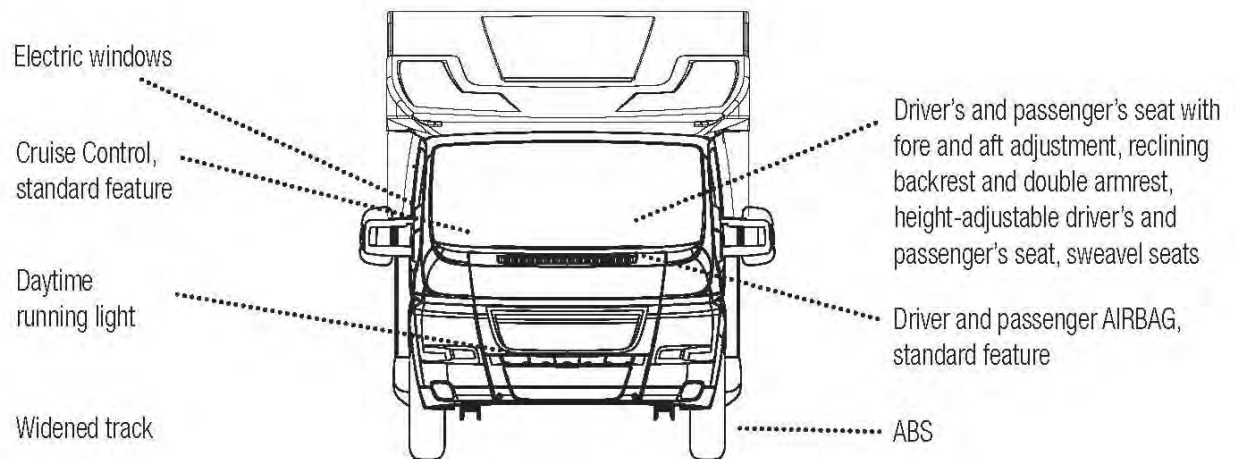
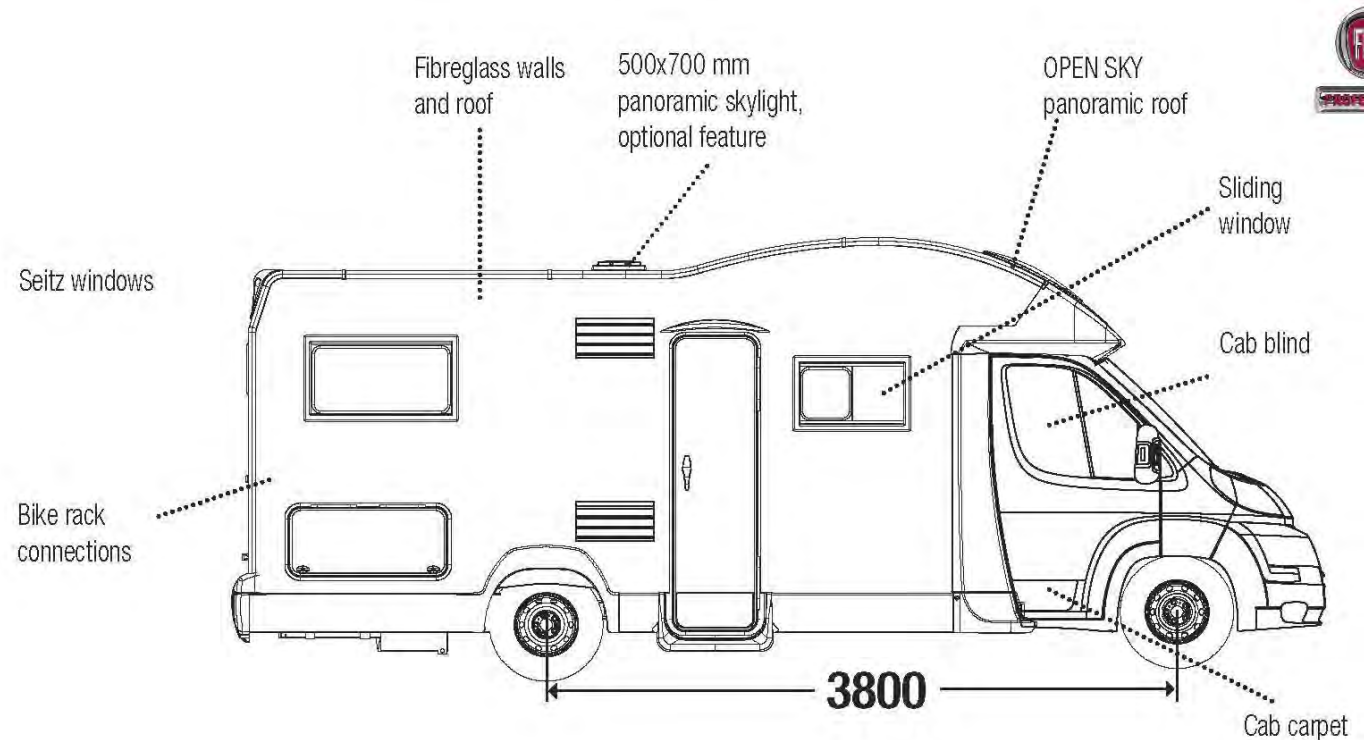

2.3MJ

Comfort Pack	●
Clima Plus Pack	◻
Automatic Pack	◻

● Standard ◻ Optional



Luna

Ivory

## S-Line 670 Family



Fiat Ducato 250  
2.3MJ - 130HP - 35  
2.3MJ - 150HP - 35



4



6



6



970x420 mm

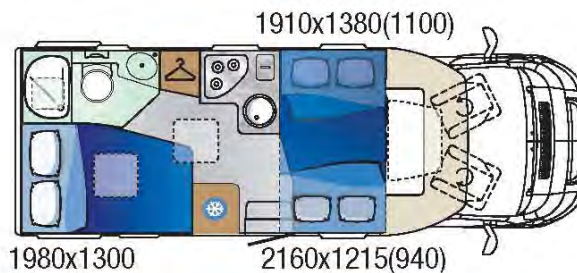
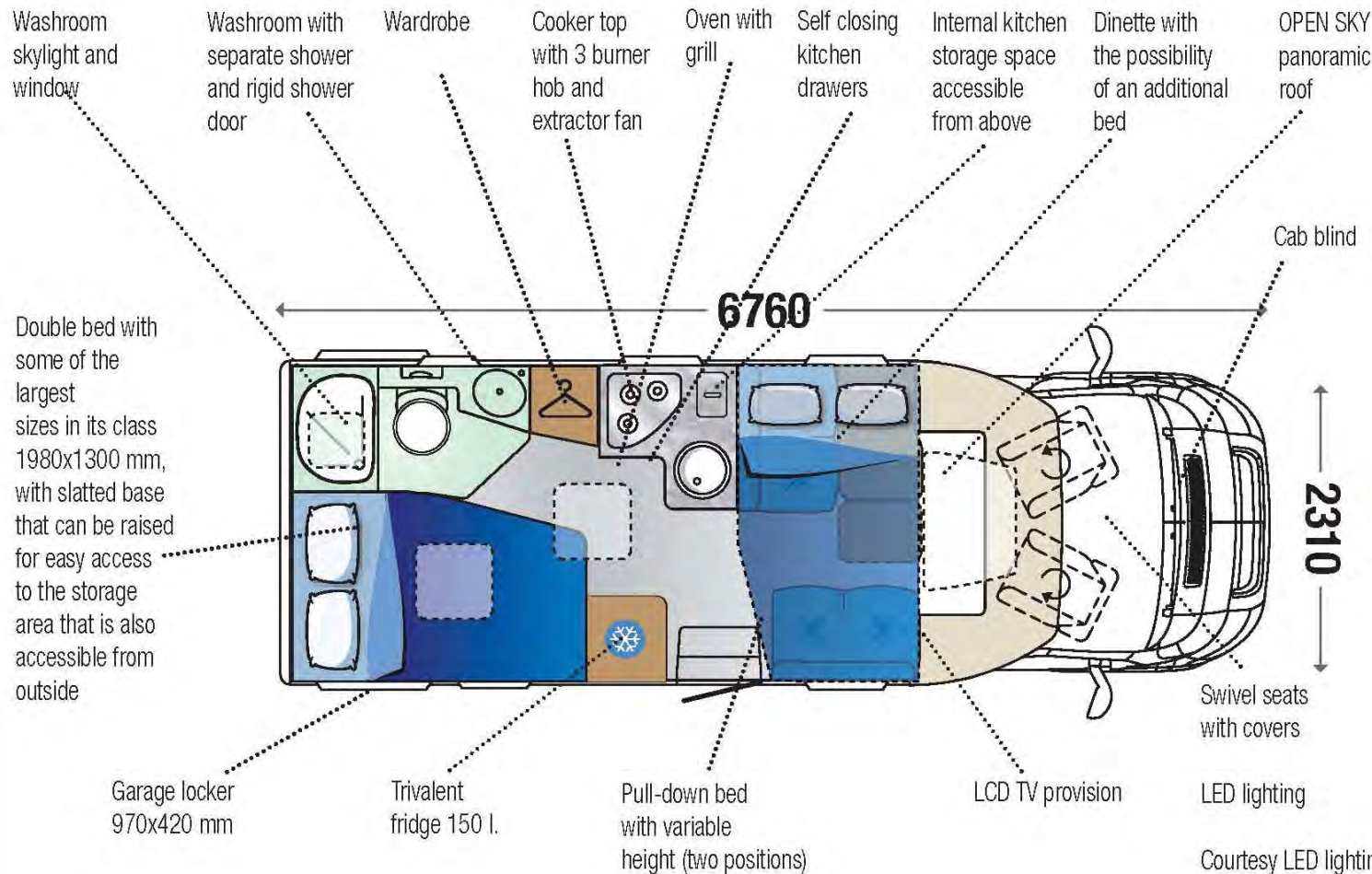

Clean water tank capacity / wastewater /  
Chemical W 100 / 105+50 / 17,5 l.

Standard heating  
Gas combi 4000W



- Version with elevating bed, with bunk beds
- L-shaped kitchen
- Two-position elevating bed
- LED lighting
- Oven with grill

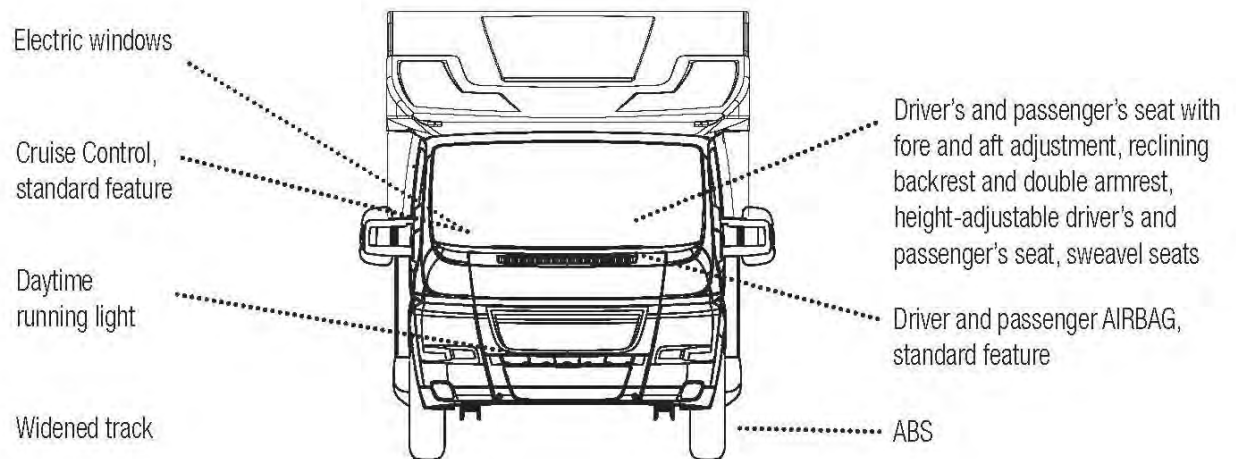
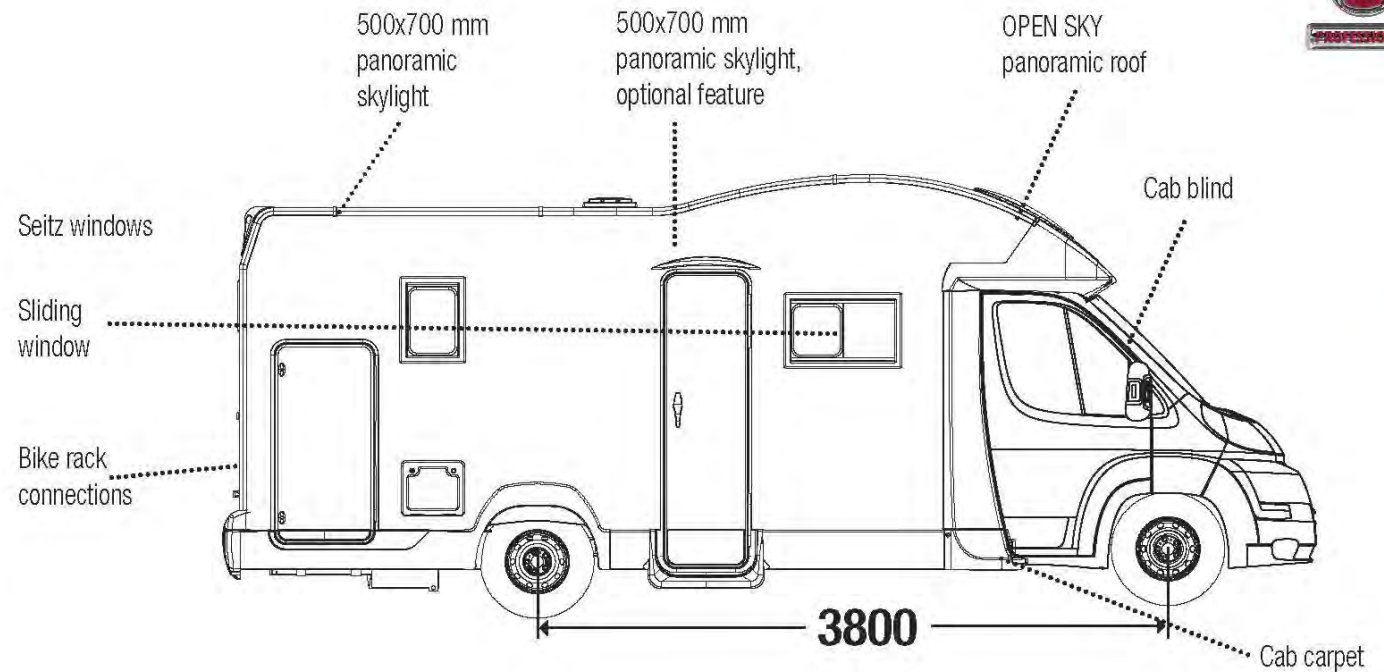

2.3MJ

Comfort Pack	●
Clima Plus Pack	◻
Automatic Pack	◻

● Standard ◻ Optional



Luna

Ivory

## S-Line 680 Family



Fiat Ducato 250  
 2.0MJ - 115HP - 35  
 2.3MJ - 130HP - 35  
 2.3MJ - 150HP - 35



4



6



6



1230x600 mm (x2)

Variable volume garage locker with folding bottom bed, size 1230x600 mm with lowering capabilities

Wardrobe

Trivalent fridge 150 l. optional feature

Cooker top with 3 burner hob and extractor fan

Oven with grill

Self closing kitchen drawers

Internal kitchen storage space accessible from above

Dinette with the possibility of an additional bed, optional feature

OPEN SKY panoramic roof

Cab blind

Bunk beds with slatted base that can be raised for easy access to the locker

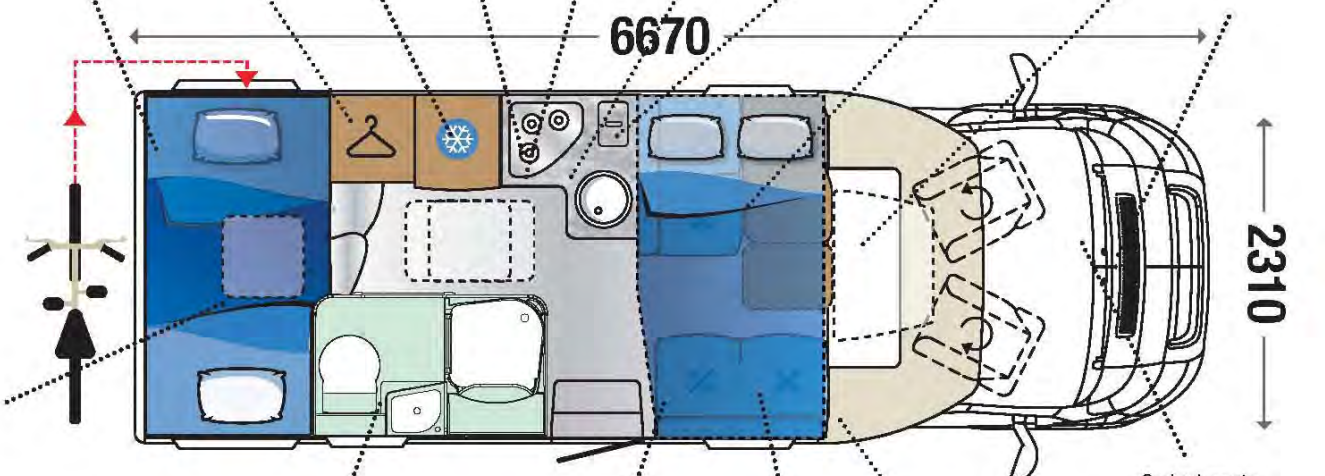

Washroom with separate shower and rigid shower door

Pull-down bed with variable height (two positions)

Fifth homologated seat, optional feature

LCD TV provision

Swivel seats with covers

LED lighting

Courtesy LED lighting

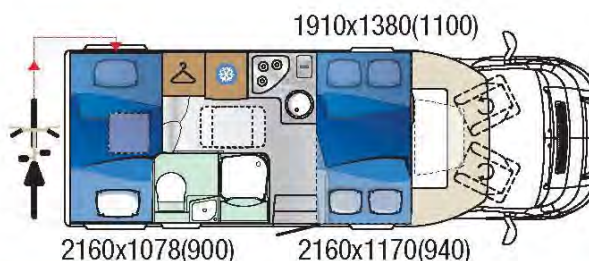

Clean water tank capacity / wastewater / Chemical W 100 / 108 / 17 l.

Standard heating  
 Fuel oil 3500w

# Standard Features

# S-Line 700

- Version with elevating bed, with garage
- Under 7 metres
- With SKY DOME (900x800)
- Maxi garage with Flex Space
- L-shaped kitchen
- Two-position elevating bed
- LED lighting
- Oven with grill

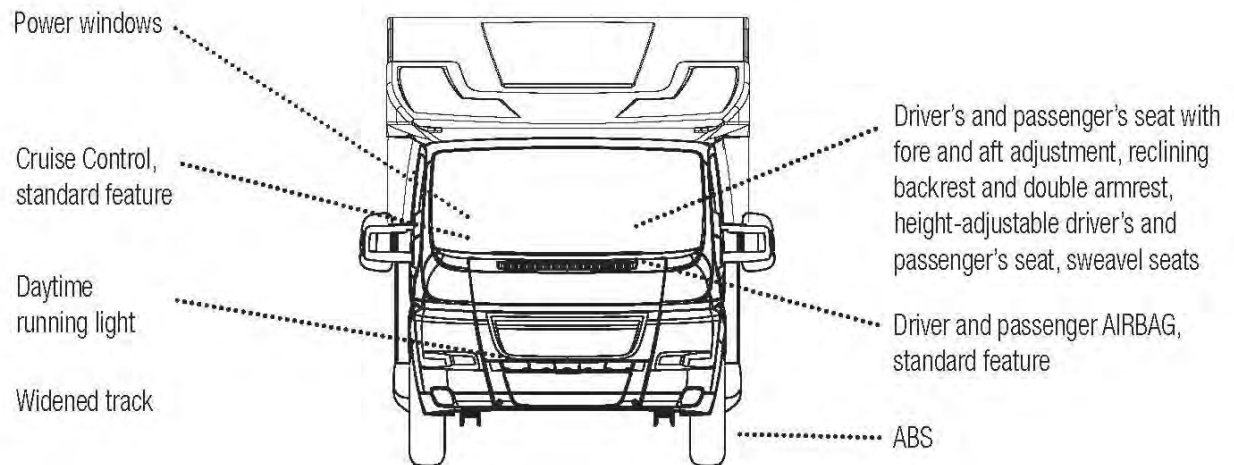
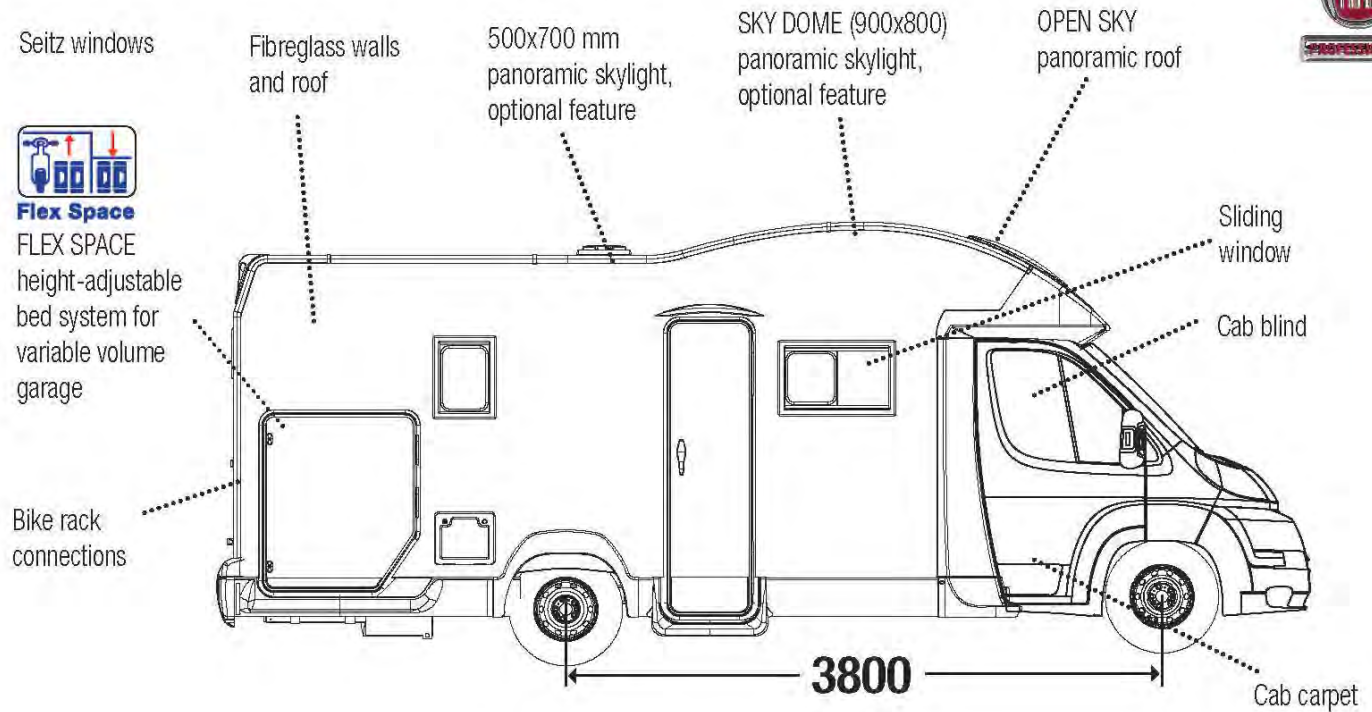

2.3MJ

Comfort Pack	●
Clima Plus Pack	◻
Automatic Pack	◻

● Standard ◻ Optional

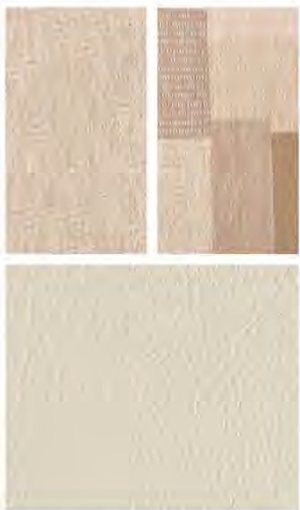

Luna



Ivory



## S-Line 700



Fiat Ducato 250  
2.3MJ - 130HP - 35  
2.3MJ - 150HP - 35



2



2



6



970x1130 mm (x2)

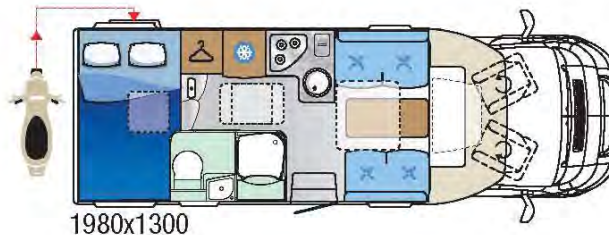
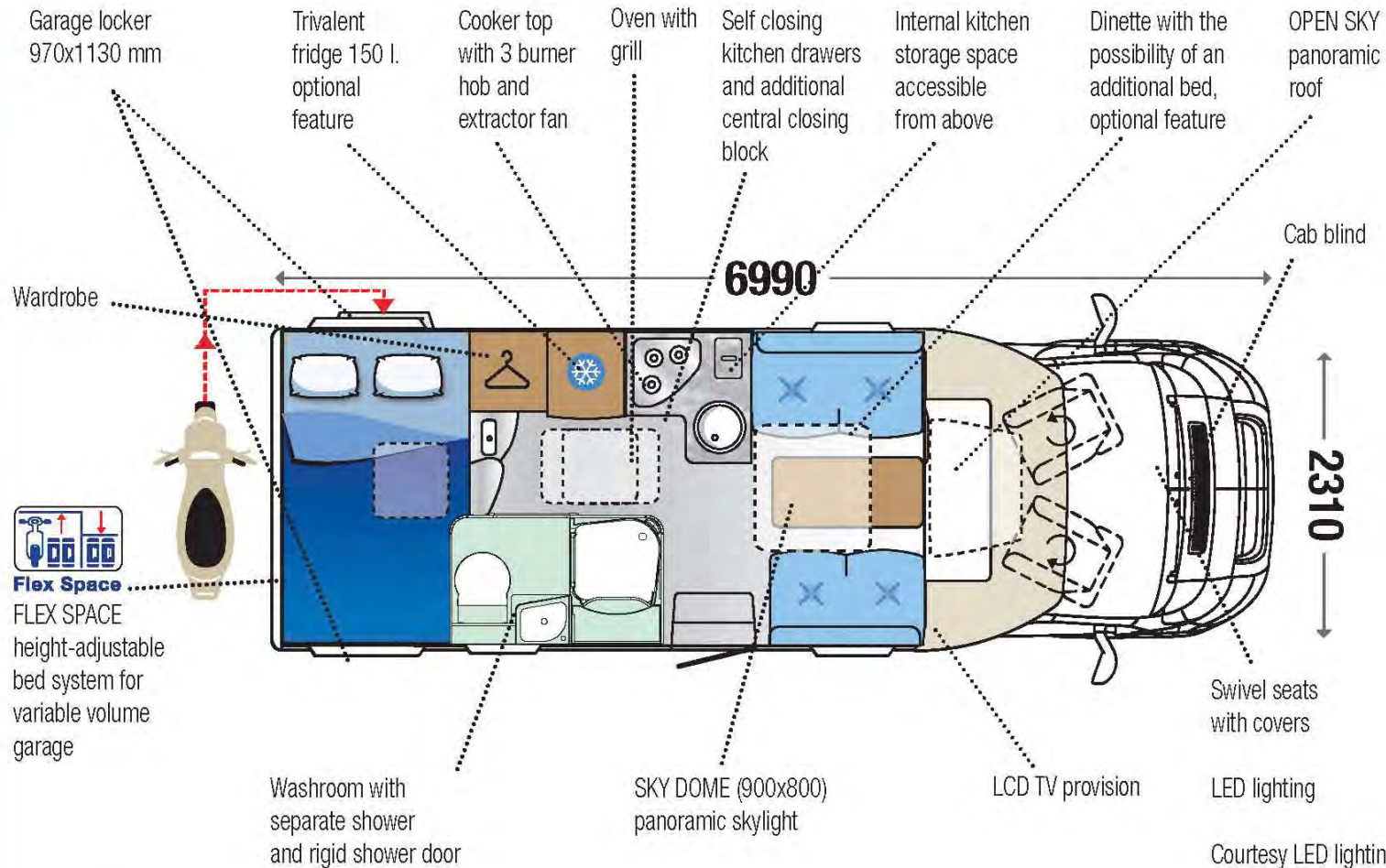

Clean water tank capacity /  
wastewater / Chemical W 100 / 108 / 17 l.

Standard heating  
Fuel oil 3500w

- Version with elevating bed, with garage, under 7 metres
- OPEN SKY panoramic roof
- Maxi garage with Flex Space
- L-shaped kitchen
- Up to 5 certified seats
- Two-position elevating bed
- LED lighting
- Oven with grill

2.3MJ

Comfort Pack	●
Clima Plus Pack	◻
Automatic Pack	◻

● Standard ◻ Optional

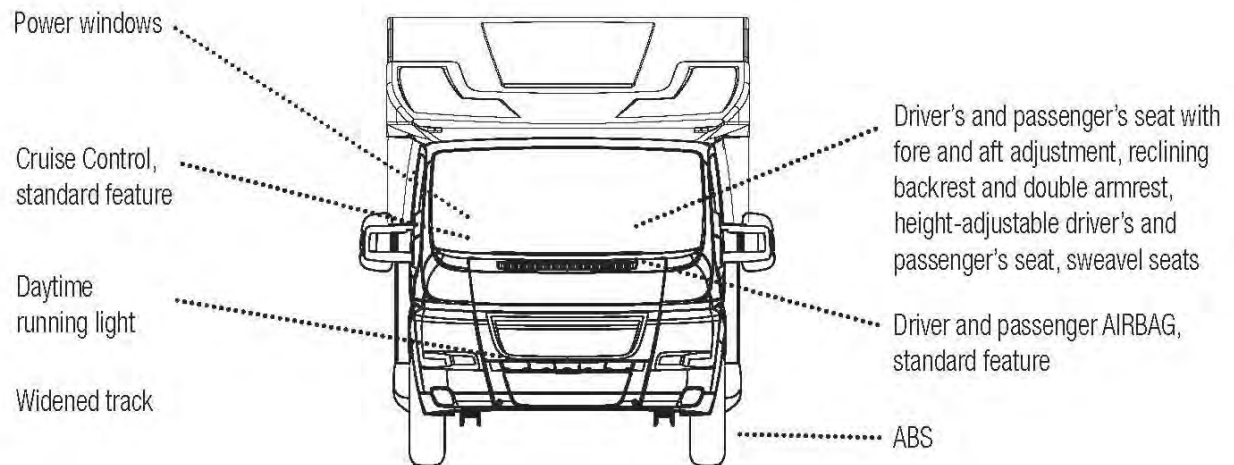
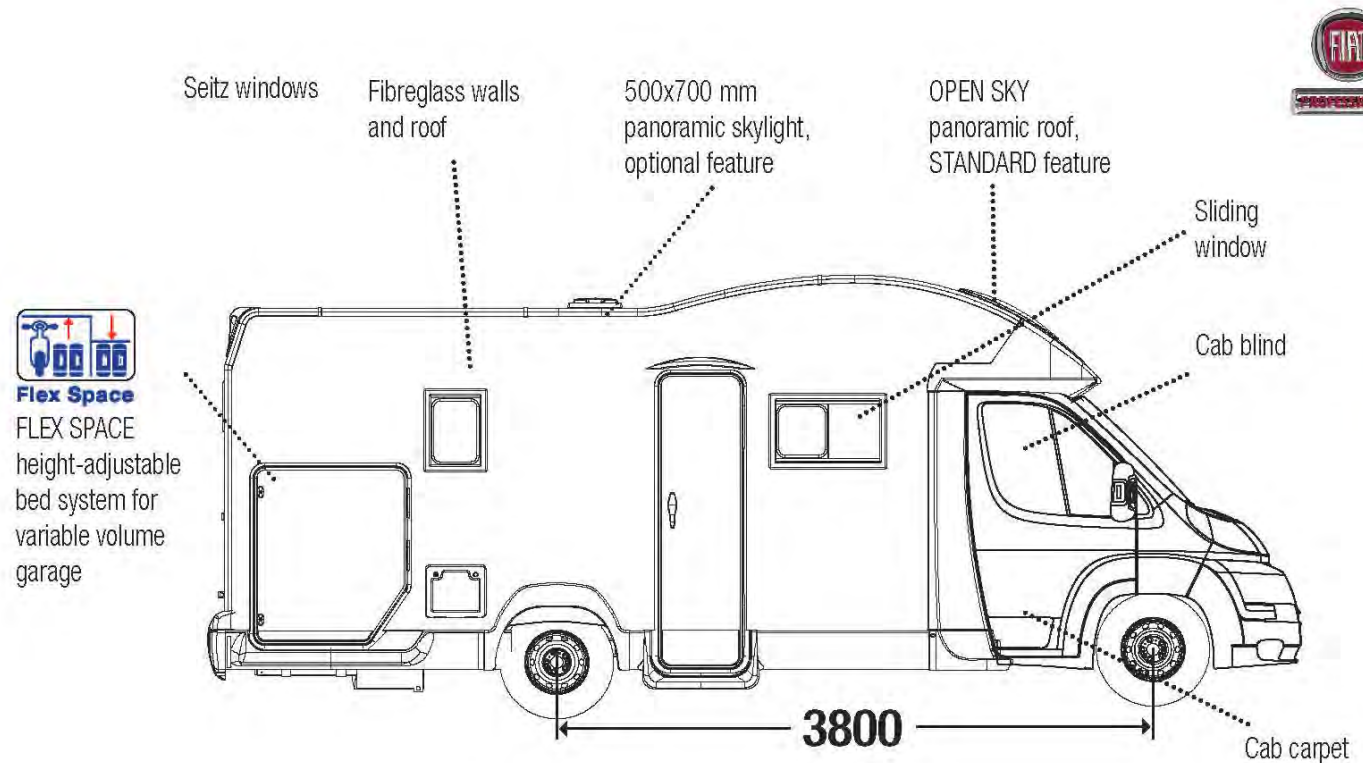





Luna

Ivory

## S-Line 700 Family



Fiat Ducato 250  
 2.0MJ - 115HP - 35  
 2.3MJ - 130HP - 35  
 2.3MJ - 150HP - 35



4(5 OPT)



6



6



970x1130 mm (x2)



**Flex Space**  
 FLEX SPACE  
 height-adjustable  
 bed system for  
 variable volume  
 garage

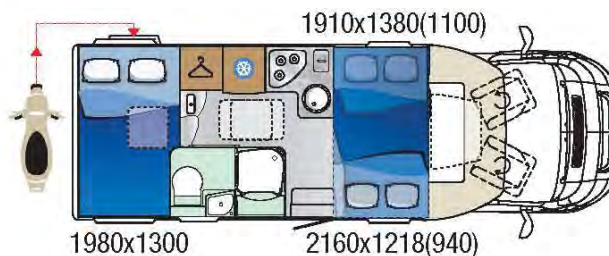
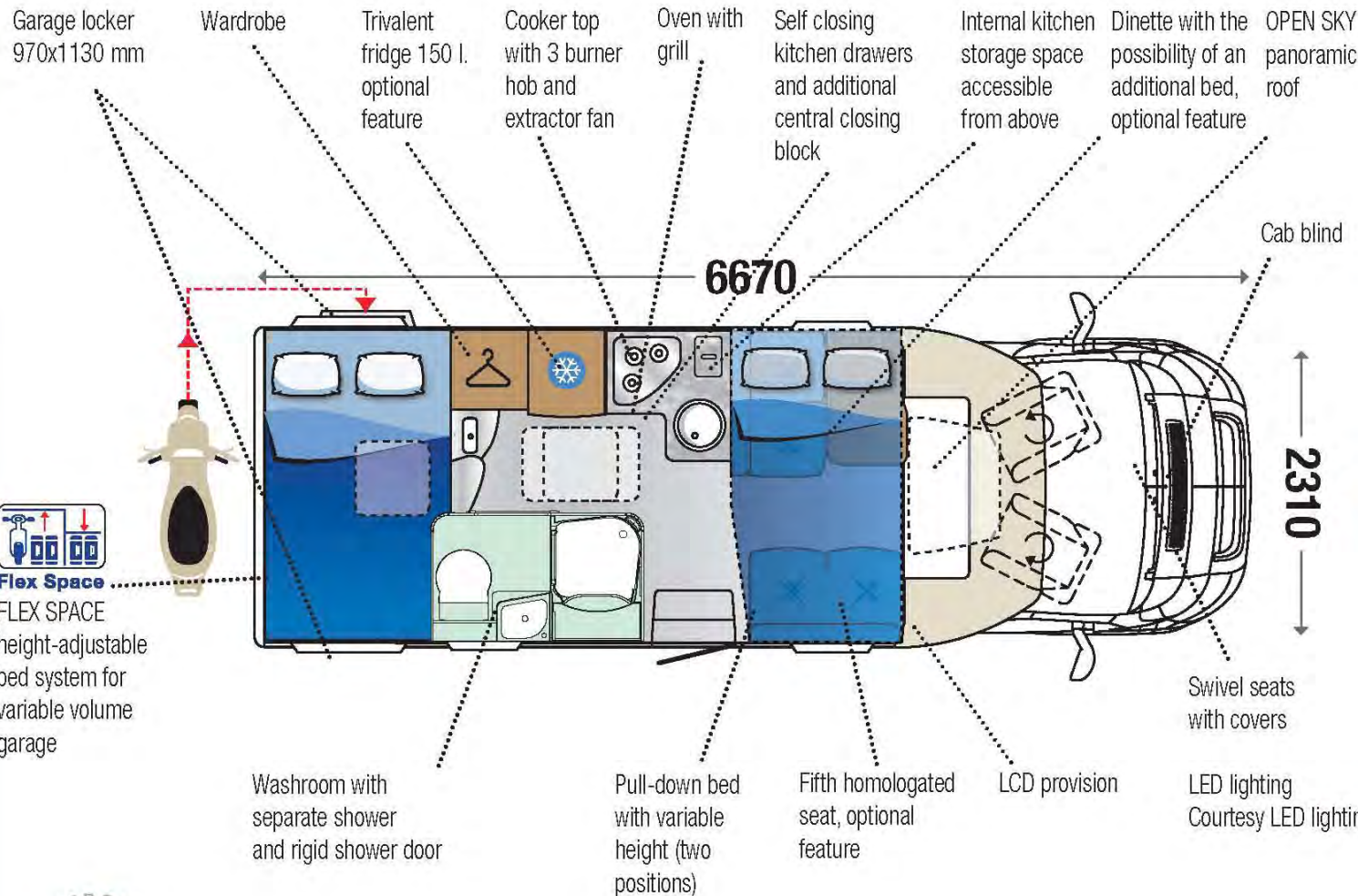

Clean water tank capacity /  
 wastewater / Chemical W 100 / 108 / 17 l.

Standard heating  
 Fuel oil 3500w

# MECHANICAL FITTINGS



**Comfort Pack:** D12-01

Wide track, spare wheel, special camping tyres, central cab docking with remote control, power windows, ABS, driver and passenger's AIRBAG, passenger and driver's seats with fore and aft adjustment, height-adjustable driver's seat, colour coded bumpers, cruise control, Daytime running lights.

**Clima Plus Pack:** F12-01

double rear electric view mirrors, air conditioning

**Automatic Pack:** F12-01

automatic gearbox, leather steering wheel and gearshift knob.

NOTES: The standard FIAT chassis has a 60 litre fuel tank with a view to increasing payload while still guaranteeing high running autonomy.



OPEN SKY panoramic roof (640x650 mm), optional feature



Cooker top with three burners and glass cover



Rear bed access steps with stowage space



SKY DOME panoramic roof (900x800 mm), standard feature (mod. 670, 700)



FLEX SPACE height-adjustable bed system for variable volume garage, optional feature (mod. 700, 700 Family)



Wooden Washroom



Swivel seats with covers, optional



Gloss laminated table and kitchen top



Rigid shower door, standard feature



LED lighting



Table and dinette extension for up to 5 seats



Courtesy LED lighting



Oven with grill



Upholstery in eco-leather, optional feature



Fridge with curved door 150 l



LCD TV provision for TV stand with extractable arm for viewing from the dinette and from the bed in the intermediate and low position.



Control unit with liquid crystal display and membrane controls

The information and photos provided are indicative and not binding. Trigano reserves the right to introduce changes at any time to the technical and configuration specifications, to the equipment provided with the vehicles and, more generally, to the products for their continued improvement. Despite careful proofreading, it is not possible to exclude the presence of printing errors. Trigano S.p.A. also declines any liability concerning alterations and/or conversions brought about at a subsequent time not meeting current regulations.



Trigano S.p.A. operates with an Integrated Quality, Environment and Safety Management System by the new certification body TÜV

